

Aqua Creations
Lighting & Furniture Atelier

© All designs, as well as images, illustrations, icons, photographs, and written materials that appear as part of this catalogue (collectively, the “contents”) are copyrights of Aqua Creations Ltd. Aqua Creations reserves the right to any kind of modification in the collections.

Photographs:
© Aqua Creations, by Albi & Yuli Serfaty,
unless otherwise stated

Catalogue design and production:
Shira Kopelovitz & Elinor Gorenstein
July 2015

For technical assistance and instructions, please contact:
info@aquagallery.com

Please refer to our website for technical and specification updates:
www.aquagallery.com

Rotini Pendant in Stone, Ph. Ben Shalom Davidi



Collections

Zooid 6-15:

Zooid Wall /
Zooid Diamond /

Mino 16-29:

Simon Says Yes /
Simon Says Maybe /
Simon Says No /
Mino 18 / Mino 28 /

Mod 30-39:

Forever / Young /
Forever Young /
Mae West / Zika /

Nara 40-55:

Wall and Ceiling Fixtures /
Pendants / Mobile 3 / Mobile 4 /
Mobile 5 / Trio Pendants /
Quartet Pendants /

Stand By 56-67:

Wall and Ceiling Fixtures /
Pendants / Trio Pendant /
Quartet Pendant /
Mobile 3 / Mobile 5 /

Sunsa 68-75:

Sunsa 10 / Sunsa 21 /

Jewel 76-89:

Nana 100 / Nana 200 /
Single Shade / Double Shade/
Gail 2 / Gail 3 /
Avia, Ease and Grace Mobiles/

Orchestra 90-109:

Doe / Soprano /
Sahara Floor & Wall /
Sikus Floor & Wall /
Bassito / Rigua / Maestro /
Viola / Contrare / Same Same /
Liana / Liana S /

Morning Glory 110-141:

Morning Glory / Horn /
Merkid / 64 Happy Days /
46 Happy Days / Medusa /
Evening Glory 100 / Candy /
Fan / Coral / Baby Coral /
Dippa / Perlina / Suuria /
Suuria Son / Chili / Rotini /

Palm 142-151:

Palm Tree / Palm /
3 Palm / 5 Palm / 9 Palm /

Molecules 152-159:

96 Molecules Table Lamp /
96 Molecules Tall Table Lamp /
96 Molecules Tall Floor Lamp /
Five Molecules Mobile Pendant /
96 Molecules Wall Lamp /

Mimosa 160-167:

Mimosa Pendant /
Mimosa Five Pendant /
Mimosa One Meter /
Mimosa Flat Pendant /
Mimosa Floor Lamp/

Apaya 168-175:

Apaya Tinka / Apaya Ponyo /
Apaya Pamuy /

Live and Let Dye 176-179:

Custom printed Morning Glory/
Custom printed Simon Says -
Composition, "Dark Snow" /

Furniture 180-193:

Anana Poof / Anana Bench /
Gladis Love Seat /
Gladis Lounge Chair /
Shasta / Bubbles / Satala /

More:

This is Aqua 194 /
Lighting Technology 198 /
Dimming Options and
Recommendations 200 /
Silk Lighting and Colour
Swatches 202-203 /
Furniture Fabric Options
204-205 /
Protection and Care
Instructions 206 /

Zooid

Design by Albi Serfaty and Benad Dar

The Zooid represents a new era for our atelier, and new collections to come established on Aqua Creations' renewed aesthetic values. The light is perfectly distributed through the geometric shapes and creates a delightful interplay of soft fabric, robust construction, light and shadows. The Zooid as well as the Diamond Pyramid Collections are highly customizable.

Zooid Wall /
Zooid Diamond Pendant /



Zooid Wall
Wall Fixture



Zooid wall is the first member of the Zooid Collection. Just as in nature, Zooids may be used as single fixtures or grouped together forming a 3 dimensional composition.

Side view



220-240 V Model
Tubular FL with ECG
2 x 24W bulbs
Optional:
Tubular FL dimmable
[Type J] 2 x 24W

120 V Model
Tubular FL with ECG
2 x 24W bulbs
Optional:
Tubular FL dimmable
[Type J] 2 x 24W UL Listed

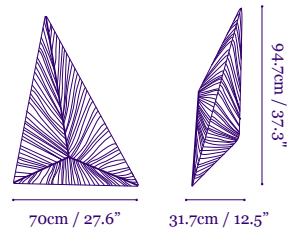

Zooid Wall Fixture in Custom printed turquoise silk

Zooid Diamond Pendant



Bottom view of the Zooid Diamond Pendant with custom printed two-toned blue silk

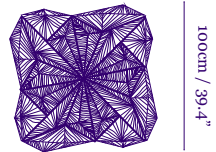

100cm / 39.4"

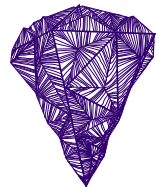

180cm / 70.8"

Approximately 70kg

- 100-240 V
- Approximately 550W
- Tubular FL with ECG
- 8 x 55w bulbs
- Circular FL with ECG
- 2 x 55W bulbs



Zooid Diamond Pendant with custom printed two-toned blue silk. H 180cm x W 100cm

Custom Pyramid pendant in Rust silk



Zooid Diamond Pendant with custom printed Silver silk, Siafian Tollgard Design Store, London

Custom Pyramid ceiling fixture in Stone silk



Mino

Design by Albi Serfaty and Benad Dar

The Mino Collection's modernist forms complement Aqua's Silk Lighting Collections adding streamlined, geometric shapes. Silk is sculpted over polycarbonate shells creating lightweight structures that may function as space dividers with Mino floor or lighting wall constellations with Simon Says.

Simon Says Yes /
Simon Says Maybe /
Simon Says No /
Mino 18 / Mino 28 /

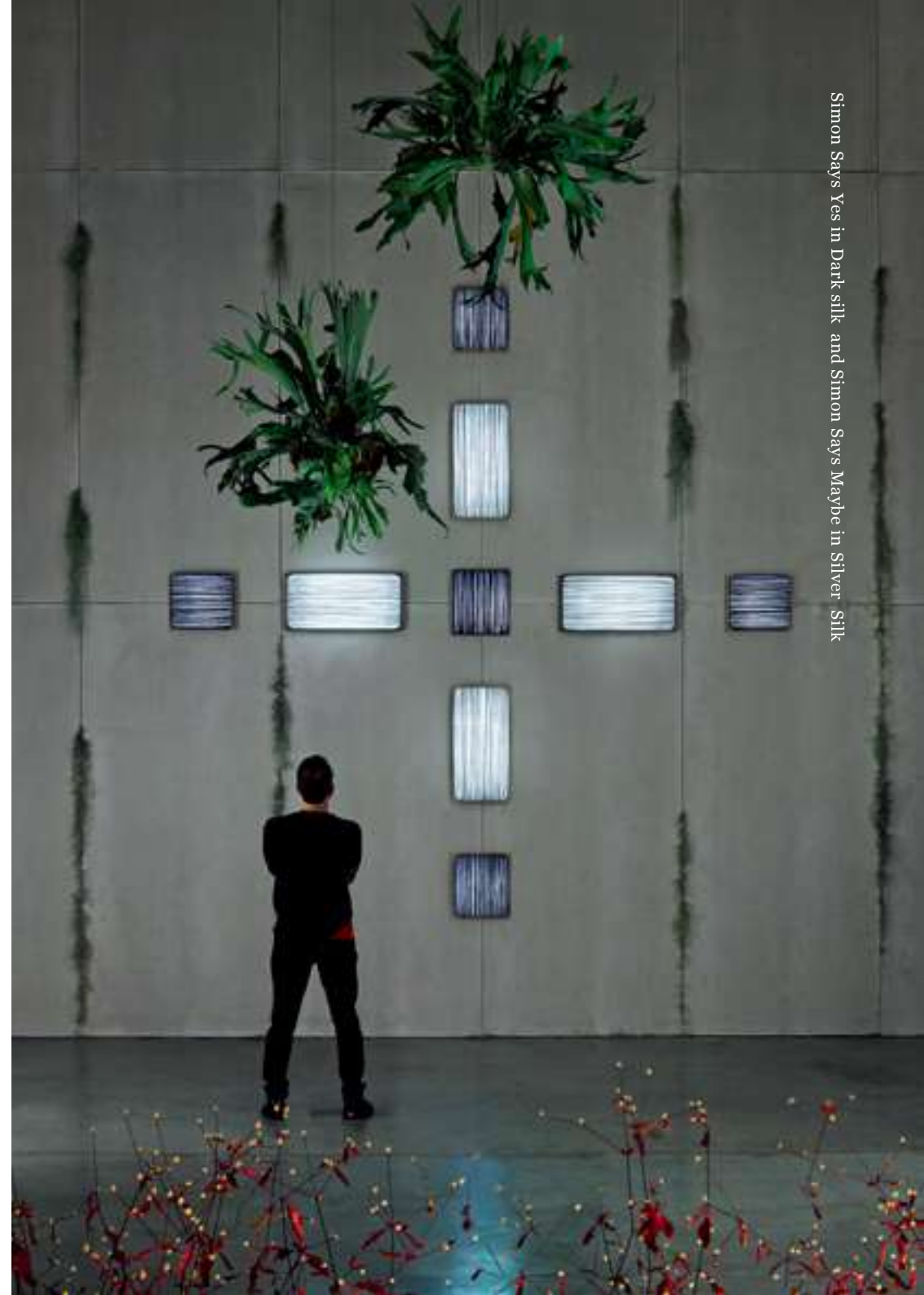



Simon Says Yes and Simon Says No in Cream, Shell and Grass silk

Simon Says Yes

Wall Fixture



Simon Says Yes in Curry with Mahogany frame and Simon Says Coal with Oak frame

Frame option:

Mahogany with oak detail or oak with mahogany detail

*Available with Touch Dim as well

220-240 V Model

CFL with ECG

2 x 18W bulbs

Optional:

CFL with ECG

dimnable [Type C,J]

2 x 18W bulbs

120 V Model

CFL with ECG

2 x 18W bulbs

Optional:

CFL with ECG

dimnable [Type A]

2 x 18W bulbs

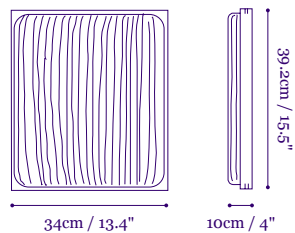

Simon Says corner in Cream silk, Mahogany frame with oak wood detail

Simon Says Maybe

Wall Fixture



Simon Says Maybe in Redwood with Oak Frame and Simon Says Maybe in Grass with Mahogany frame

Frame option:
Mahogany with oak detail or oak with mahogany detail

*Available with Touch Dim as well

220-240 V Model

Tubular FL with ECG
2 x 24W bulbs
Optional:
Tubular FL with ECG
dimnable [Type C, J]
2 x 24W

120 V Model

Tubular FL with ECG
2 x 24W bulbs
UL Listed
Optional:
Tubular FL with ECG
2 x 24W bulbs [Type A]

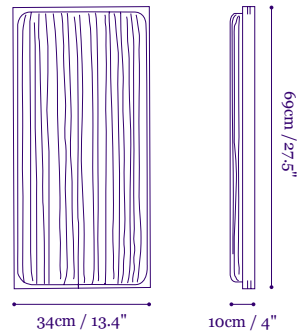

Simon Says No

Wall Fixture



Simon Says No in Stone with Oak frame

Frame option:
Mahogany with oak detail
or oak with mahogany detail

220-240 V Model

Tubular FL with ECG
4 x 24W bulbs
Optional:
Tubular FL with ECG
dimnable [Type C, J]
4 x 24W

120 V Model

Tubular FL with ECG
4 x 24W bulbs
UL Listed
Optional:
Tubular FL with ECG
4 x 24 bulbs [Type A]

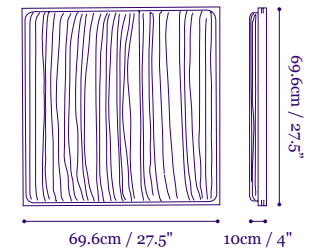



Simon Says Wall Composition. Ph. Richard Gooding at Staffan Tollgard Design Store, London

Mino 18
Floor Lamp



Mino 18 in Shell

220-240V
Tubular FL with ECG
2 x 49W bulbs dimmable
Touch dimming switch.

120V
Tubular FL with ECG
2 x 35W bulbs dimmable
Touch dimming switch.

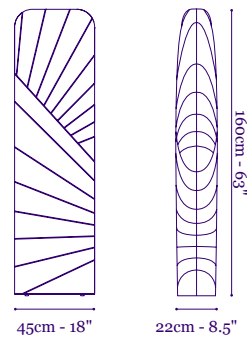

Mino 28
Floor Lamp



Mino 28 in Smoke and Gold

120-240V
Tubular FL with ECG
2 x 39W bulbs dimmable
Touch dimming switch.

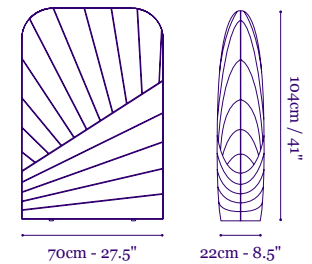



Mino Collection in Dark, Silver, Gold, Shell, Flame and Grass silk

Mod

Design by Aqua Creations

The Mod Collection consists of modular tiles that may also be used as singular fixtures. The modular designs allow innumerable wall or ceiling illuminated patterns, in compositions and scales according to each individual's desire and need. The collection is extensive, offering a variety of options united by a geometrical yet organically sensual appeal.

Forever / Young /
Forever Young /
Mae West / Zika /



Zika wall composition in Cream silk

Forever
Wall Linear Tile

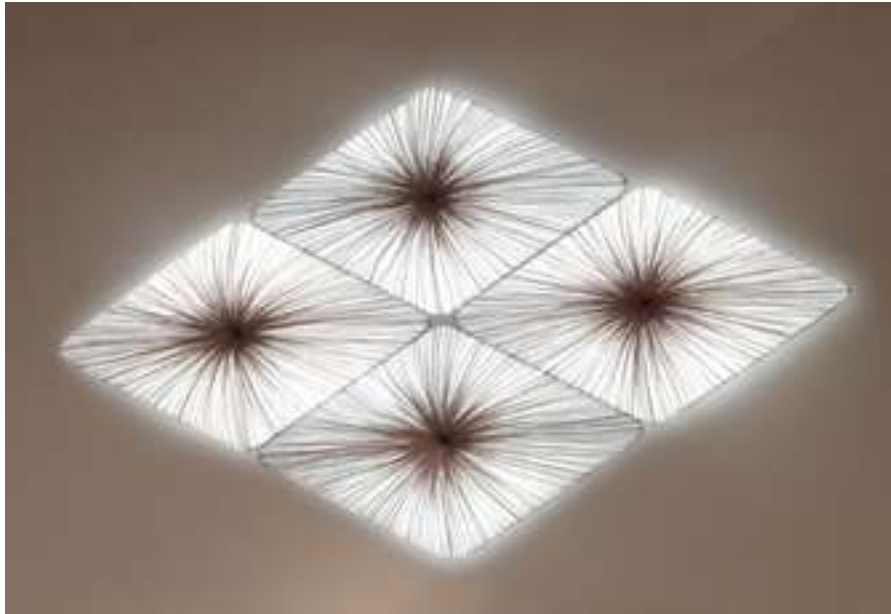

Forever wall composition in Silver

220-240V
Circular FL with ECG
1 x 55W bulb
Optional:
Circular FL with ECG
dimmable [Type C, E, J]
1 x 55W bulb

120V UL listed
Circular FL with ECG
1 x 55W bulb
Optional:
Circular FL with ECG
dimmable [Type A]
1 x 55W bulb

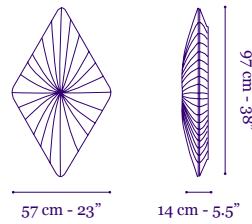

Forever wall composition in Curry and Orange, private residence

Young
Wall and Ceiling Linear Tile

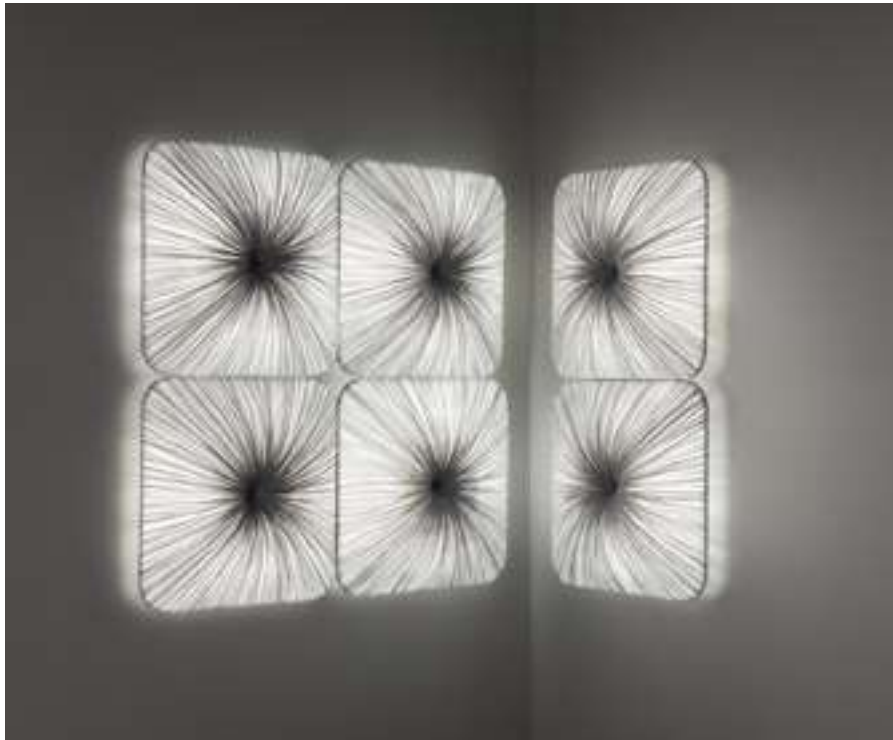

Young wall composition in Silver

220-240V
Circular FL with ECG
1 x 55W bulb
Optional:
Circular FL with ECG
dimnable [Type C, E, J]
1 x 55W bulb

120V UL listed
Circular FL with ECG
dimnable 1 x 55W bulb
Optional:
Circular FL with ECG
[Type A] 1 x 55W bulb

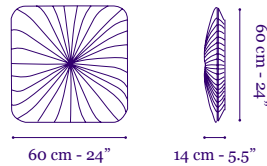

Forever Young
Wall Multiple Compositions



Forever Young ceiling composition, Excelsior Hotel, Thessaloniki, Greece

*Please provide a sketch of desired composition.

The electrical features of the composition will be the sum of the electrical features in each tile used.

220-240V
Circular FL with ECG
2 x 55W bulbs
Optional:
Circular FL with ECG
dimnable [Type C, E]
2 x 55W bulbs

120V UL listed
Circular FL with ECG
2 x 55W bulbs
Optional:
Circular FL with ECG
dimnable [Type A]
2 x 55W bulbs

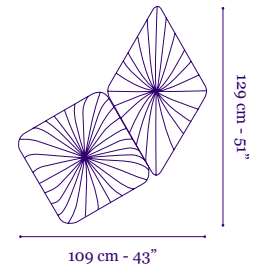

Mae West
Wall Linear Tile



Singular West wall tile in Silver

For an order of several fixtures to be installed in a composition, customers should provide a document outlining the desired composition.

Please note: For an order of a singular fixture, Mae should be ordered if horizontal installation is desired; West should be ordered for vertical installation.

220-240V
CFL with ECG 2 x 36W bulbs
Optional:
CFL with ECG dimmable
[Type C, E, J] 2 x 36W bulb

120V UL listed
CFL with ECG 2 x 36W bulbs
Optional:
CFL with ECG [Type A]
2 x 36W bulbs

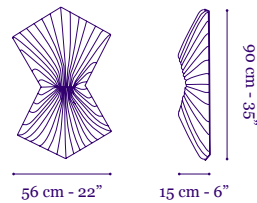

Zika
Wall and Ceiling Linear Tile



Zika wall composition in Gold

220-240V
CFL with ECG 2 x 18W bulbs
Optional:
CFL Screw-in dimmable
[Type A] 2 x 18W bulbs
CFL with ECG dimmable
[Type C, E, J] 2 x 18W bulbs

120V UL listed
CFL with ECG 2 x 18W bulbs
Optional:
dimmable [Type A]
2 x 18W bulbs

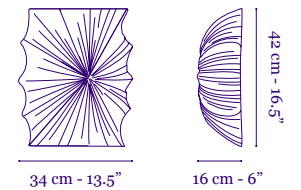



Nara

Design by Aqua Creations

The Nara Collection of playful rounded squares derives its name from the ancient Japanese capital, which was built in a grid-like pattern. The classic square is always chic and has an elegant effect on any room. This particular design introduces a combination of hand crafted silk with plain geometry. The Nara lamps come in multiple sizes as ceiling lights, wall fixtures and pendants. They may be placed as singular lamps or as a grouped installation.

Wall and Ceiling Fixtures /
Pendants / Mobile 3 /
Mobile 4 / Mobile 5 /
Trio Pendants /
Quartet Pendants /



Nara

Wall and Ceiling Fixtures



Test installation of Custom Nara 240cm / 94"

220-240V

120V UL listed

Nara 60

Circular FL with ECG
1 x 55W bulb

Optional:
Circular FL with ECG
dimnable [Type C, E, J]
1 x 55W bulb

Nara 24

CFL with ECG dimmable
[Type A]
4 x 14W bulbs



Nara 76

Circular FL with ECG
1 x 55W bulb

Optional:
Circular FL with ECG
dimnable [Type C, E, J]
1 x 55W bulb

Nara 30

CFL with ECG dimmable
[Type A]
4 x 14W bulbs



Nara 90

Circular FL with ECG
2 x 55W bulbs

Optional:
Circular FL with ECG
dimnable [Type C, E, J]
2 x 55W bulbs

Nara 35

Circular FL with ECG
dimmable [Type A]
2 x 55W bulbs



Nara 60 wall fixture in Silver silk

Nara

Wall and Ceiling Fixtures



Nara wall fixtures in Smoke and Stone

220-240V

120V UL listed

Nara 122x90

Tubular FL with ECG
4 x 55W bulbs
Optional:
Tubular FL with ECG
dimmable [Type C, E, J]
4 x 55W bulbs

Nara 48x35

Tubular FL with ECG
dimmable [Type A]
4 x 55W bulbs

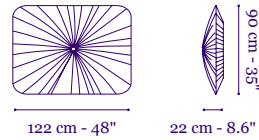

Nara 122

Circular FL with ECG
4 x 55W bulbs
Optional:
Circular FL with ECG
dimmable [Type C, E, J]
4 x 55W bulbs

Nara 48

Circular FL with ECG
dimmable [Type A]
4 x 55W bulbs

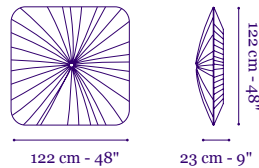

Nara 180

Circular FL with ECG
6 x 55W bulbs
Optional:
Circular FL with ECG
dimmable [Type C, E, J]
6 x 55W bulbs

Nara 72

Circular FL with ECG
dimmable [Type A]
6 x 55W bulbs

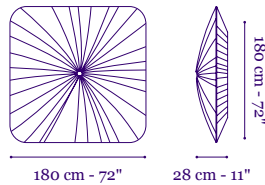

Nara wall fixture in Flame silk



Custom Nara in Stone silk and Morning Glory in Curry silk. Lighting design: Sphinx Lichttechnik AG

Nara Pendants



The Nara pendants are suspended from a brushed stainless steel ceiling plate 20 cm x 20 cm - 8" x 8", by a 2 mm stainless steel cable, in adjustable heights up to 200 cm - 78" long, with a clear electrical cord. Shades can be balanced horizontally or up to 30 degrees diagonal.

220-240V

Nara 60
Circular FL with ECG
1 x 55W bulb
Optional:
Circular FL with ECG
dimmable [Type C, E, J]
1 x 55W bulb

120V UL listed

Nara 24
Circular FL with ECG
dimmable [Type A]
1 x 55W bulb

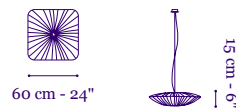

220-240V

Nara 76
Circular FL with ECG
1 x 55W bulb
Optional:
Circular FL with ECG
dimmable [Type C, E, J]
1 x 55W bulb

Nara 90

Circular FL with ECG
2 x 55W bulbs
Optional:
Circular FL with ECG
dimmable [Type C, E, J]
2 x 55W bulbs

Nara 122x90

Tubular FL with ECG
4 x 55W bulbs
Optional:
Tubular FL with ECG
dimmable [Type C, E, J]
4 x 55W bulbs

Nara 122

Circular FL with ECG
4 x 55W bulbs
Optional:
Circular FL with ECG
dimmable [Type C, E, J]
4 x 55W bulbs

Nara 156

Circular FL with ECG
6 x 55W bulbs
Optional:
Circular FL with ECG
dimmable [Type C, E, J]
6 x 55W bulbs

120V UL listed

Nara 30
Circular FL with ECG
dimmable [Type A]
1 x 55W bulb

Nara 35

Circular FL with ECG
dimmable [Type A]
2 x 55W bulbs

Nara 48x35

Tubular FL with ECG
dimmable [Type A]
4 x 55W bulbs

Nara 48

Circular FL with ECG
dimmable [Type A]
4 x 55W bulbs

Nara 61

Circular FL with ECG
dimmable [Type A]
6 x 55W bulbs

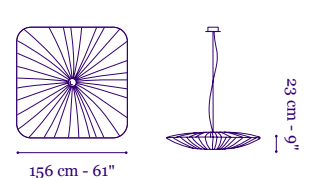
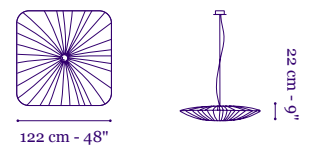
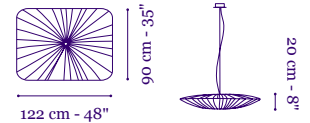
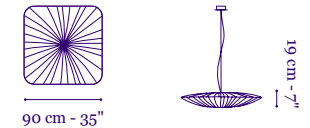

Nara Mobiles



Mobiles are suspended from a brushed stainless steel ceiling plate, a 4 mm stainless steel cable, pre-cut to specified length, with a clear electrical cord.

Nara Mobile 3

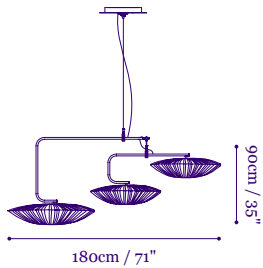

220-240 V Model
Circular FL with ECG
3 x 55W bulbs
Optional:
Dimmable [Type C, E, J]

120 V Model
Circular FL with ECG
3 x 55W bulbs
Optional:
Dimmable [Type A]
UL Listed
2 shades 60cm/24",
1 shade 76cm/30"

Nara Mobile 4

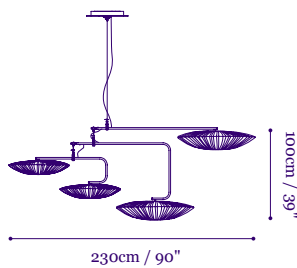

220-240 V Model
Circular FL with ECG
4 x 55W bulbs
Optional:
Dimmable [Type C, E, J]

120 V Model
Circular FL with ECG
4 x 55W bulbs
Optional:
Dimmable [Type A]
UL Listed
2 shades 60cm/24",
2 shades 76cm/30"

Nara Mobile 5

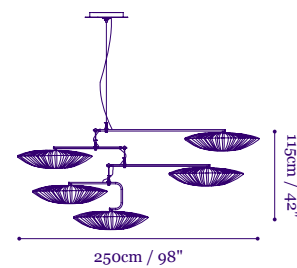

220-240 V Model
Circular FL with ECG
5 x 55W bulbs
Optional:
Dimmable [Type C, E, J]

120 V Model
Circular FL with ECG
5 x 55W bulbs
Optional:
Dimmable [Type A]
UL Listed
5 shades 76cm/30"



Nara
Trio Pendants



Nara Trio Pendant in custom silk color and custom ceiling plate

230 V Model

Circular FL with ECG

10 x 55W bulbs

Optional:

Circular FL with ECG

dimmbable [Type C, E, J]

10 x 55W bulbs

Composition 1

1 shade 90 cm/35"

1 shade 122 cm/48"

1 shade 156 cm/61"

10 x 55W bulbs

Composition 2

2 shades 90cm/35"

1 shade 122 cm/48"

8 x 55W bulbs

Composition 3

1 shade 60cm/24"

1 shade 76cm/30"

1 shade 84cm/33"

4 x 55W bulbs

*Additional Nara Trio Compositions available.

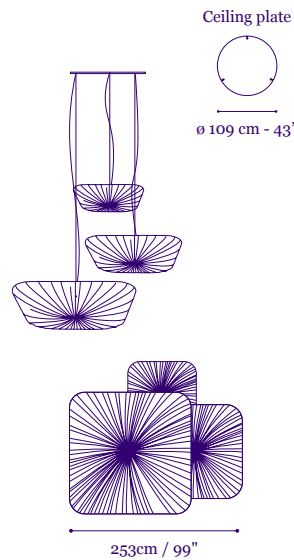

*Output power of the composition equals summary of output powers for each shade.

Nara
Quartet Pendants



Bottom view of Nara Quartet Pendant in Gold and Smoke silk

230 V Model

Circular FL with ECG

12 x 55W bulbs

Optional:

Circular FL with ECG

dimmbable [Type C, E, J]

12x 55W bulbs

Composition 1

2 shades 90cm /35"

1 shade 122 cm /48"

1 shade 156 cm /61"

12 x 55W bulbs

Composition 2

3 shades 90cm/35"

1 shade 122 cm/48"

10 x 55W bulbs

Composition 3

1 shade 60cm/24"

1 shade 68cm/27"

1 shade 76cm/30"

1 shade 84cm/33"

5 x 55W bulbs

*Additional Nara Quartet Compositions available.

120 V Model UL listed

Circular FL with ECG

12x 55W bulbs

Optional:

Circular FL with ECG

dimmbable [Type A,]

12x 55W bulbs

*Output power of the composition equals summary of output powers for each shade.

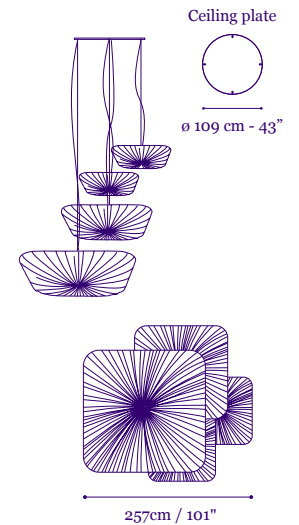

Custom Ceiling Panels, Radisson Hotel, Bucharest, Romania. Photo: Serban Boncioieat



Stand By

Design by Aqua Creations

The Stand By Collection of perfectly round shaped discs feature a combination of pure simplicity and glamour. Stand By elegantly radiates brilliance across large areas and adds a unique refinement to any space. The multiple sizes and colors of the Stand By make it a versatile and adaptable contemporary lighting collection. They come as ceiling lights, wall fixtures and pendants. They can be placed as a singular lamp or as a grouped composition.

Wall and Ceiling Fixtures /
Pendants / Trio Pendant /
Quartet Pendant / Mobile 3 /
Mobile 5 /



Stand By

Wall and Ceiling Fixtures

220-240V

Stand By 60

Circular FL with ECG
1 x 55W bulb

Optional:

Circular FL with ECG
dimmable [Type C, E, J]
1 x 55W bulb

Stand By 76

Circular FL with ECG
1 x 55W bulb

Optional:

Circular FL with ECG
dimmable [Type C, E, J]
1 x 55W bulb

Stand By 90

Circular FL with ECG
2 x 55W bulbs

Optional:

Circular FL with ECG
dimmable [Type C, E, J]
2 x 55W bulbs

Stand By 122

Circular FL with ECG
4 x 55W bulbs

Optional:

Circular FL with ECG
dimmable [Type C, E, J]
4 x 55W bulbs

Stand By 156

CFL with ECG 4 x 55W bulbs

Optional:

CFL with ECG dimmable
[Type C, E, J] 4 x 55W bulbs

120V UL listed

Stand By 24

CFL with ECG dimmable
[Type A] 3 x 23W bulb



ø60 cm - 24"



15 cm - 6"

Stand By 30

CFL with ECG dimmable
[Type A] 3 x 23W bulb

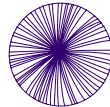

ø76 cm - 30"



15 cm - 6"

Stand By 35

Circular FL with ECG
dimmable [Type A]
2 x 55W bulbs

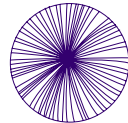

ø90 cm - 35"



17 cm - 7"

Stand By 48

Circular FL with ECG
dimmable [Type A]
4 x 55W bulbs

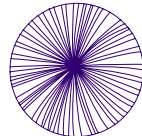

ø122 cm - 48"



21.5 cm - 8.5"

Stand By 61

Circular FL with ECG
dimmable [Type A]
4 x 55W bulbs

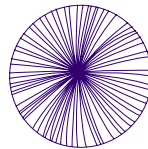

ø156 cm - 61"



23 cm - 8.5"

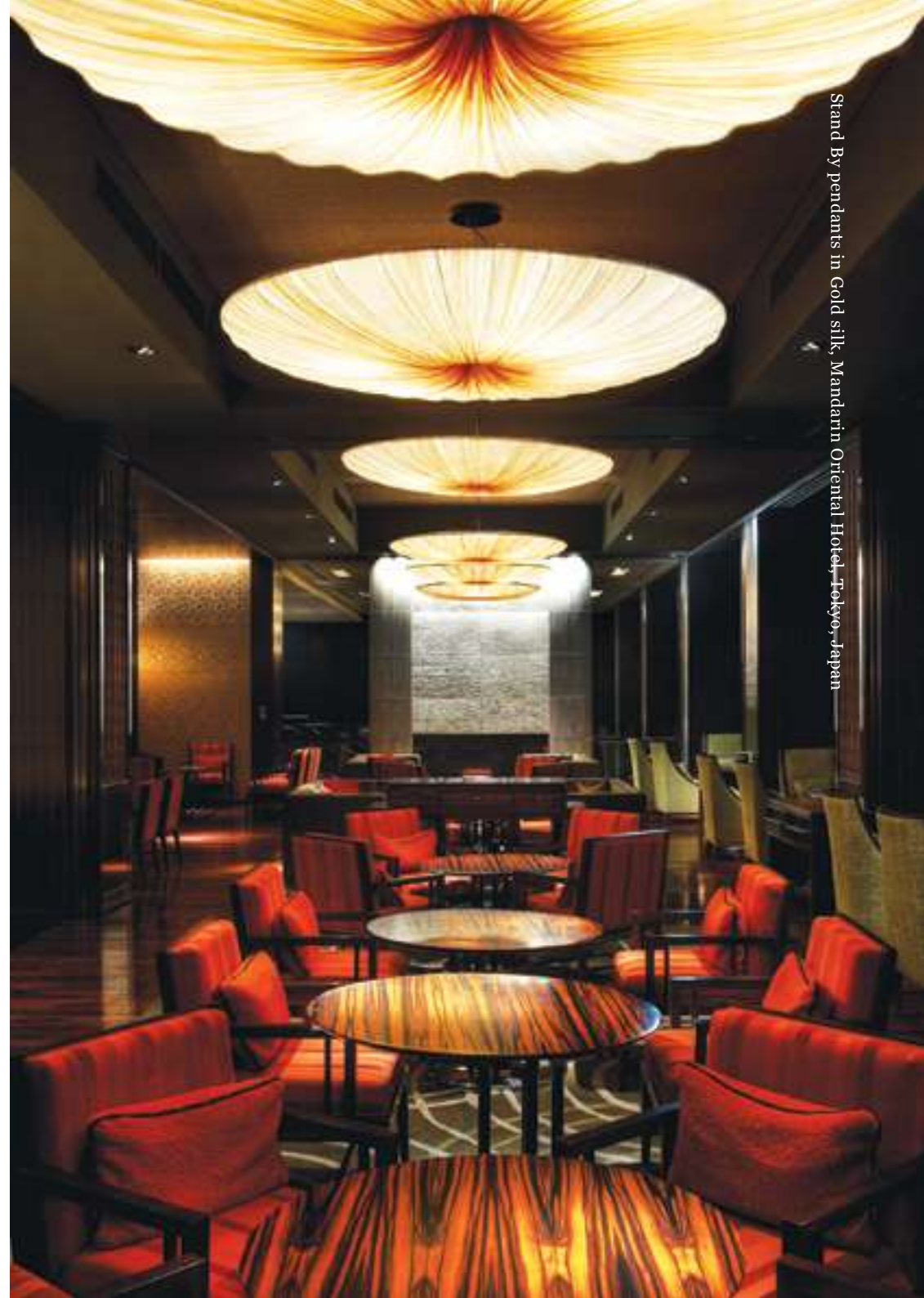

Stand By pendants in Gold silk, Mandarin Oriental Hotel, Tokyo, Japan

Stand By Pendants



Stand By 122 in Flame silk with Gladis Armchair

Stand By pendants are suspended from a brushed stainless steel ceiling plate \varnothing 20 cm - 8", by a 2 mm stainless steel cable, in adjustable height, up to 200 cm - 78" long, with a clear electrical cord. Shades can be balanced horizontally or up to 30 degrees diagonal.

220-240V

Stand By 60

Circular FL with ECG
1 x 55W bulb
Optional:
Circular FL with ECG
dimmable [Type C, E, J]
1 x 55W bulb

Stand By 68

Circular FL with ECG
1 x 55W bulb
Optional:
Circular FL with ECG
dimmable [Type C, E, J]
1 x 55W bulb

Stand By 76

Circular FL with ECG
1 x 55W bulb
Optional:
Circular FL with ECG
dimmable [Type C, E, J]
1 x 55W bulb

120V UL listed

Stand By 24

Circular FL with ECG
dimmable [Type A]
1 x 55W bulb

Stand By 27

Circular FL with ECG
dimmable [Type A]
1 x 55W bulb

Stand By 30

Circular FL with ECG
dimmable [Type A]
1 x 55W bulb

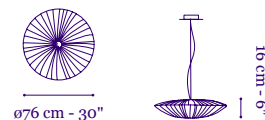
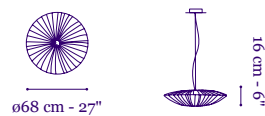

Stand By 84

Circular FL with ECG
2 x 55W bulbs
Optional:
Circular FL with ECG
dimmable [Type C, E, J]
2 x 55W bulbs

Stand By 90

Circular FL with ECG
2 x 55W bulbs
Optional:
Circular FL with ECG
dimmable [Type C, E, J]
2 x 55W bulbs

Stand By 122

Circular FL with ECG
4 x 55W bulbs
Optional:
Circular FL with ECG
dimmable [Type C, E, J]
4 x 55W bulbs

Stand By 156

Circular FL with ECG
4 x 55W bulbs
Optional:
Circular FL with ECG
dimmable [Type C, E, J]
4 x 55W bulb

Stand By 186

Circular FL with ECG
6 x 55W bulbs
Optional:
Circular FL with ECG
dimmable [Type C, E, J]
6 x 55W bulbs

Stand By 240

Circular FL with ECG
9 x 55W bulbs
Optional:
Circular FL with ECG
dimmable [Type C, E, J]
9 x 55W bulbs

Stand By 33

Circular FL with ECG
dimmable [Type A]
2 x 55W bulbs

Stand By 35

Circular FL with ECG
dimmable [Type A]
2 x 55W bulbs

Stand By 48

Circular FL with ECG
dimmable [Type A]
4 x 55W bulbs

Stand By 61

Circular FL with ECG
dimmable [Type A]
4 x 55W bulbs

Stand By 72

Circular FL with ECG
dimmable [Type A]
6 x 55W bulbs

Stand By 95

Circular FL with ECG
dimmable [Type A]
9 x 55W bulbs

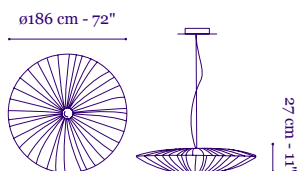
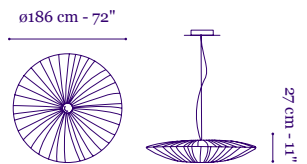
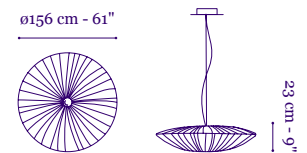
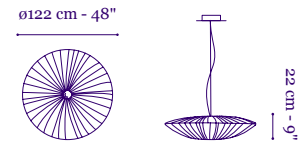
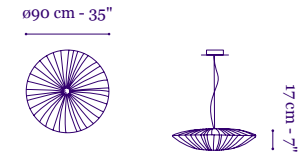
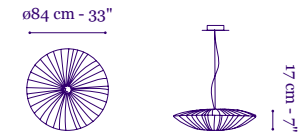

Stand By
Trio Pendants



Grouped Stand By pendants suspended on 2mm stainless steel cables in various adjustable heights from 130 cm - 51" up to 400 cm - 157" with clear electrical cords. Custom compositions are available upon request. Pendants are suspended from a wooden ceiling plate, painted in semi white satin.

220-240V
Circular FL with ECG
10 x 55W bulbs
Optional:
Circular FL with ECG
dimmable [Type C, E, J]
10 x 55W bulbs

120V UL listed
Circular FL with ECG
dimmable [Type A]
10 x 55W bulbs

Composition 1
1 shade 90 cm - 35"
1 shade 122 cm - 48"
1 shade 156 cm - 61"
10 x 55W bulbs

Composition 2
1 shade 90cm/ 35"
1 shade 90 cm/ 35"
1 shade 122cm/ 48"
8 x 55W bulbs

Composition 3
1 shade 60cm/ 24"
1 shade 76cm/ 30"
1 shade 84 cm/ 33"
4 x 55W bulbs

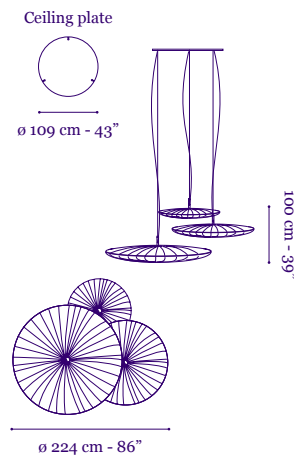

Stand By
Quartet Pendants



Grouped Stand By pendants suspended on 2mm stainless steel cables in various adjustable heights from 130 cm - 51" up to 400 cm - 157" with clear electrical cords. Custom compositions are available upon request. Pendants are suspended from a wooden ceiling plate, painted in semi white satin.

220-240V
Circular FL with ECG
12 x 55W bulbs
Optional:
Circular FL with ECG
dimmable [Type C, E, J]
12 x 55W bulbs

120V UL listed
Circular FL with ECG
dimmable [Type A]
12 x 55W bulbs

Composition 1
2 shades 90 cm - 35"
1 shade 120 cm - 48"
1 shade 156 cm - 61"
12 x 55W bulbs

Composition 2
3 shades 90 cm/ 35"
1 shade 122cm/ 48"
10 x 55W bulbs

Composition 3
1 shade 60cm/24"
1 shade 68cm/27"
1 shade 76cm/30"
1 shade 84 cm/33"
5 x 55W bulbs

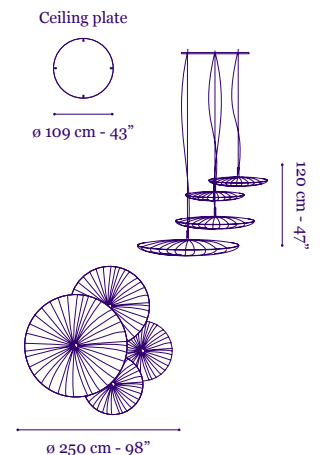

Stand By
Mobile 3



Stand By Mobile 3 in Smoke silk

Mobiles are suspended from a brushed stainless steel ceiling plate, a 4 mm stainless steel cable, pre-cut to specified length, with a clear electrical cord.

220-240 V Model

Circular FL with ECG

3 x 55W bulbs

Optional:

Circular FL with ECG

Dimmable [Type C, E, J]

3 x 55W bulbs

120 V Model

Circular FL with ECG

3 x 55W bulbs

Optional:

Circular FL with ECG

Dimmable [Type A]

3 x 55W bulbs UL Listed

Dimensions

3 shades of 60cm / 24"

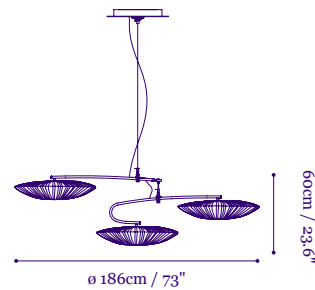

Cable length is not included within the 60cm / 23.6" height measurements.

Stand By
Mobile 5



Stand By Mobile 5 Cream and Orange silk

Mobiles are suspended from a brushed stainless steel ceiling plate, a 4 mm stainless steel cable, pre-cut to specified length, with a clear electrical cord.

220-240 V Model

Circular FL with ECG

7 x 55W bulbs

Optional:

Circular FL with ECG

Dimmable [Type C, E, J]

7 x 55W bulbs

120 V Model

Circular FL with ECG

7 x 55W bulbs

Optional:

Circular FL with ECG

Dimmable [Type A]

7 x 55W bulbs UL Listed

Dimensions

Shades: 60cm / 24", 68cm / 27", 76cm / 30", 84cm / 33", 90cm / 35"

Cable length is not included within the 110cm / 43.3" height measurements.

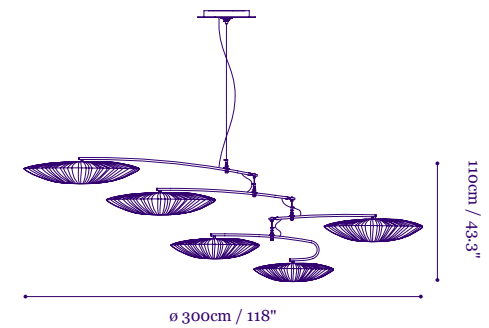

Stand By Mobile 3 in Gold silk, Caroline Astor Suite, St. Regis Istanbul



Sunsa

Design by Aqua Creations

The Sunsa chandelier collection suggests visions of radiant luminous clouds, or leaves over water. The combination of the various shades creates a magnificent cellular structure that showcases the strength of the whole, representing both serenity and vitality. This chandelier is highly customizable to fit a specific space.

Sunsa 10 / Sunsa 21 /



Sunsa 10
Chandelier



The structure of the Sunsa Chandelier is made of brushed stainless steel.

Shades ø 60 cm - 24"
Minimum chandelier length:
80 cm - 32"
Chandelier ø 224 cm - 88"
Weight: 67kg - 150lb

220-240V or 120V UL listed
CFL Screw-in 20 x 23W bulbs
Total output Power: 460W

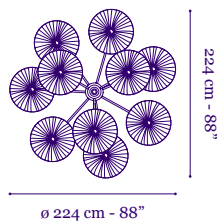

Shades ø 76 cm - 30"
Minimum chandelier length:
80 cm - 32"
Chandelier ø 254 cm - 100"
Weight: 90kg - 200lb

220-240V or 120V UL listed
CFL Screw-in 30 x 23W bulbs
Total output Power: 690W

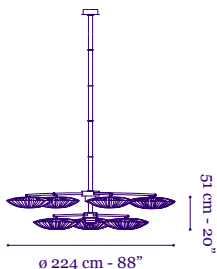

Sunsa 21
Chandelier



The structure of the Sunsa Chandelier is made of brushed stainless steel.
Maximum chandelier length: 600 cm - 320", Maximum chandelier diameter: 330 cm - 130"

Shades ø 60 cm - 24"
Minimum chandelier length:
150 cm - 60"
Chandelier ø 300 cm - 118"
Weight: 135kg - 300lb

220-240V or 120V UL listed
CFL Screw-in 42 x 23W bulbs
Total output Power: 966W

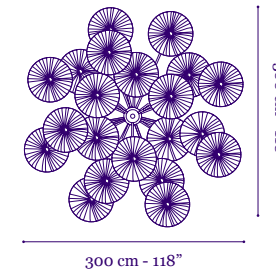

Shades ø 76 cm - 30"
Minimum chandelier length:
150 cm - 60"
Chandelier ø 330 cm - 130"
Weight: 185kg / 415lb

220-240V or 120V UL listed
CFL Screw-in 63 x 23W bulbs
Total output Power: 1,449W

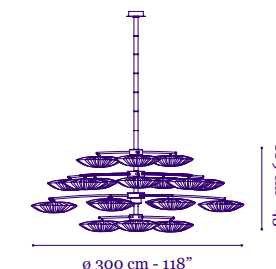

Custom Sunsa, 5 meter high and 6 meter diameter with sahes in Silver, Rust and Grass silk



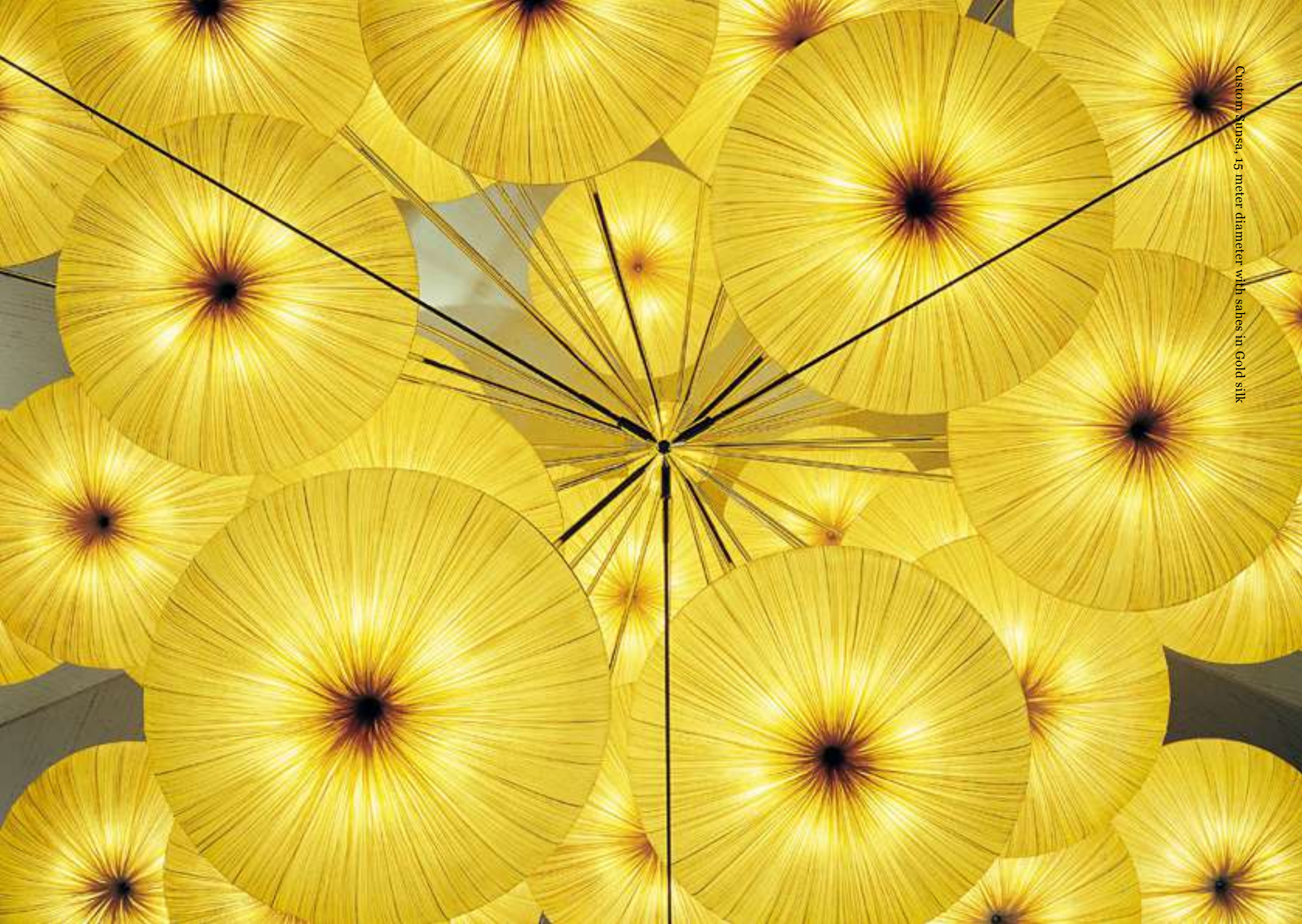

Custom Sunsa, 15 meter diameter with sahes in Gold silk

Jewel

Design by Aqua Creations

The Jewel collection of elegant and lyrical suspended kinetic mobiles is intended for large spaces. The mobile structures allow the creation of variable compositions of shades that sway as if blown by a breeze. Their movement creates a magical environment. The pieces in this collection are customizable including single and multiple shade options to fit a specific space.

Nana 100 / Nana 200 /
Single Shade / Double Shade/
Gail 2 / Gail 3 /
Avia, Ease and Grace/



Nana 100

Mobile



Nana 100 Mobile in Gold silk

The Nana 100 is suspended with a 4 mm stainless steel cable, pre-cut to specified length up to 500cm - 197", with an electrical cord. Ceiling plate ø 28 cm - 11" and structure are made of metal, powder coated in black.

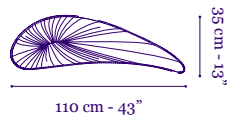
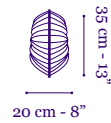
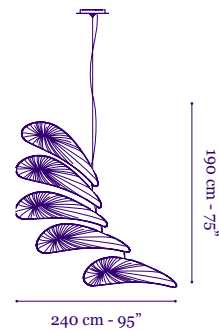

220-240V
Tubular FL with ECG
dimmable [Type C, E, J]
10 x 55W bulbs

120V UL listed
Tubular FL with ECG
dimmable [Type A]
10 x 55W bulbs

Nana 200

Mobile



Nana 200 Mobile in Grass silk

The Nana 200 is suspended with a 4 mm stainless steel cable, pre-cut to specified length up to 500cm - 197", with an electrical cord. Ceiling plate ø 28 cm - 11" and structure are made of metal, powder coated in black.

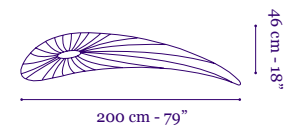
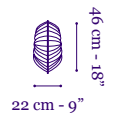
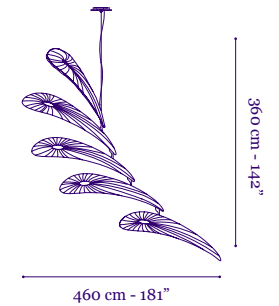

220-240V or 120V UL listed
CFL Screw-in 45 x 15W bulbs

Nana 100 and 200, Single or Double shade

Pendant



Nana 200 with two shades in Orange silk

Both Nana 100 and Nana 200 are available with three shades as well. The shade combinations can come on one or two cables.



Nana 100 Single Shade in Dark silk

Nana 100

220-240V Single Shade

Tubular FL with ECG
Dimmable [Type C, E, J]
2 x 55W bulbs

120V UL listed
Single Shade
Tubular FL with ECG
Dimmable [Type A, E]
2 x 55W bulbs

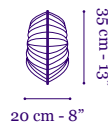

Double Shades

Tubular FL with ECG
Dimmable [Type C, E, J]
4 x 55W bulbs

Double Shades
Tubular FL with ECG
Dimmable [Type A, E]
4 x 55W bulbs

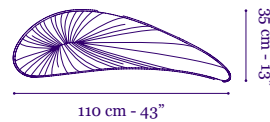

Nana 200

220-240V
Single Shade
CFL 9 x 15W bulbs

120V UL listed
Single Shade
CFL 9 x 15W bulbs



Double Shades
CFL 18 x 15W bulbs

Double Shades
CFL 18 x 15W bulbs

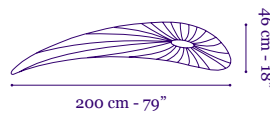



Nana 100 in Flame silk, Excelsior Hotel, Thessaloniki, Greece. Photo: Heinz Troll

Gail 2 and Gail 3

Mobile



Gail 2 and Gail 3 Mobiles in Stone silk

The Gails are suspended with a 4 mm stainless steel cable, pre-cut to specified length up to 500cm - 197", with an electrical cord. Ceiling plate \varnothing 28 cm - 11" and structure are made of metal, powder coated in black.

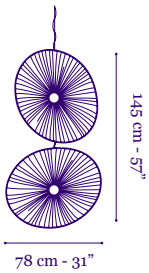

220-240V
Circular FL with ECG
dimmable [Type C, E, J]
4 x 55W bulbs

120V UL listed
Circular FL with ECG
dimmable [Type A]
4 x 55W bulbs

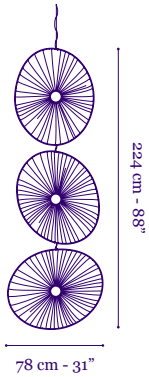

220-240V
Circular FL with ECG
dimmable [Type C, E, J]
6 x 55W bulbs

120V UL listed
Circular FL with ECG
dimmable [Type A]
6 x 55W bulbs

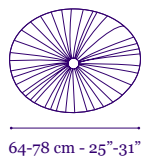
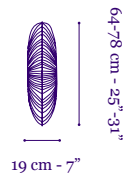

Gail 3 mobile in Curry silk, Private Residence

Avia, Ease and Grace

Mobile



Avia 7 Mobile in Dark silk

The Avia, Grace and Ease mobiles are available in 5, 7 and 8 shade combinations as well as custom constellations.

*All of the mobiles have the same electric components.
The number of bulbs change according to the number of shades.

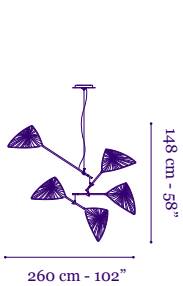

Avia 5 mobile

120V or 220-240V

Tubular FL with ECG

10 x 18W bulbs for five shades

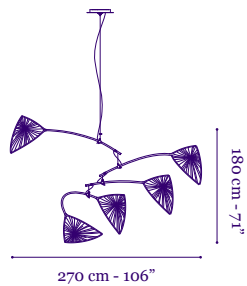

Grace 5 mobile

120V or 220-240V

Tubular FL with ECG

10 x 18W bulbs for five shades

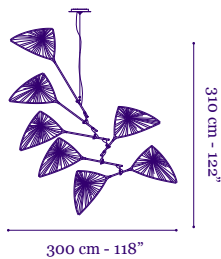

Ease 7 mobile

120V or 220-240V

Tubular FL with ECG

14 x 18W bulbs for five shades



Custom 7 shaded Ease Mobile in Grass silk



Two Grace 7 Mobiles in Stone silk, part of Aqua Creation's Heritage Collection

Orchestra

Design by Aqua Creations

The Orchestra Collection's organic figures were inspired by natural forms as well as modern sculpture and architecture. Like members of a light orchestra, each piece contributes its unique tone to create a harmony of light capturing space in any home or public area. The lighting pieces of the Orchestra Collection come in different sizes and colors, offering creative lighting solutions.

Doe / Soprano / Sahara / Sikus /
Bassito / Rigua / Maestro /
Viola / Contrare / Same Same /
Liana / Liana S. / Liana S. Small /



Doe
Table Lamp



Doe in custom colours Imperial Blue silk and Lime silk

220-240V
CFL Screw-in Dimmable
2 x 20W bulbs
Dimmable [Type A]
With dimmer

120V UL listed
CFL Screw-in dimmable
[Type A] 2 x 14W bulbs
With dimmer

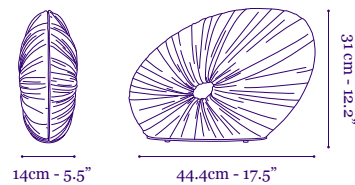

Soprano
Floor and Table Lamp



Soprano Table lamp in Gold silk and Soprano Floor lamp in Rust silk

220-240V
CFL Screw-in 4 x 15W bulbs
Optional:
CFL Screw-in dimmable
[Type A] 4 x 20W bulbs
With dimmer

120V UL listed
CFL Screw-in dimmable
[Type A] 4 x 14W bulbs
With Dimmer

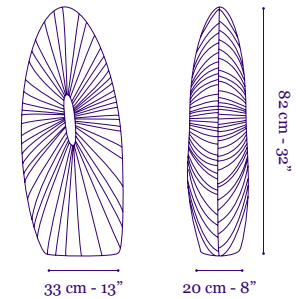



Doe in Gold, Blush, Lime, Imperial Purple, Turquoise, Grass, Rust, Redwood, Dark, Coal silks

Sahara
Floor Lamp



Sahara Floor lamp in Silver silk

220-240V
CFL Screw-in dimmable
[Type A] 6 x 20W bulbs
With dimmer

120V UL listed
CFL Screw-in dimmable
[Type A] 6 x 23W bulbs
With dimmer

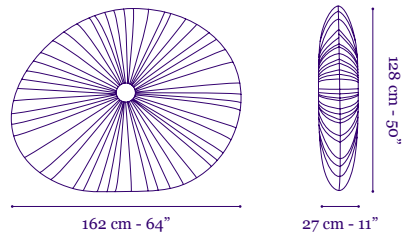

Sahara
Wall Fixture



Sahara Floor lamp in Flame and Sahara Wall fixture in Gold silk

220-240V
CFL Screw-in dimmable
[Type A] 7 x 20W bulbs

120V UL listed
CFL Screw-in dimmable
[Type A] 7 x 23W bulbs

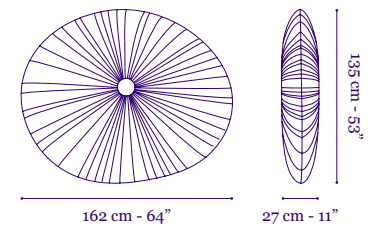

Sikus
Floor Lamp



Sikus Floor lamp in Gold silk

220-240V
CFL Screw-in dimmable
[Type A] 6 x 20W bulbs
With dimmer

120V UL listed
CFL Screw-in dimmable
[Type A] 6 x 23W bulbs
With dimmer

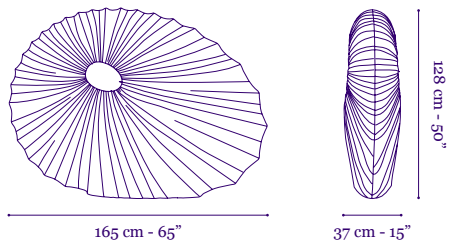

98

Sikus
Wall Fixture



Sikus Wall fixture in Dark silk

220-240V
CFL Screw-in dimmable
[Type A] 6 x 20W bulbs

120V UL listed
CFL Screw-in dimmable
[Type A] 6 x 23W bulbs

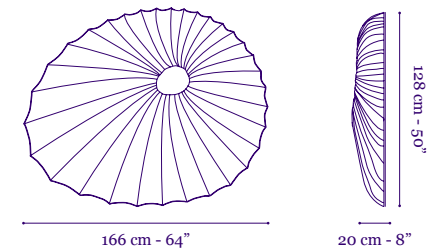

99

Bassito
Floor Lamp



Bassito Floor lamp in Stone silk

220-240V
CFL Screw-in 5 x 15W bulbs
Optional:
CFL Screw-in dimmable
[Type A] 5 x 20W bulbs
With dimmer

120V UL listed
CFL Screw-in dimmable
[Type A] 5 x 14W bulbs
With dimmer

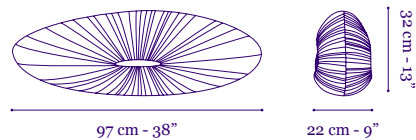

Rigua
Floor and Table Lamp



Rigua Floor and Table lamp in Sand silk

220-240V
CFL Screw-in 4 x 15W bulbs
Optional:
CFL Screw-in dimmable
[Type A] 4 x 20W bulbs
With dimmer

120V UL listed
CFL Screw-in dimmable
[Type A] 4 x 14W bulbs
With dimmer

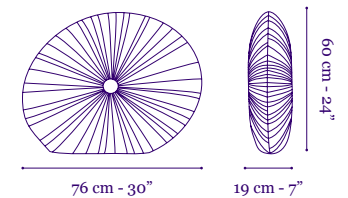

Maestro
Floor Lamp



Maestro Floor lamps in Gold silk

220-240V
Tubular FL with ECG
dimmable [Type C, E]
4 x 55W bulbs

120V UL listed
Tubular FL with ECG
dimmable [Type C, E]
4 x 55W bulbs

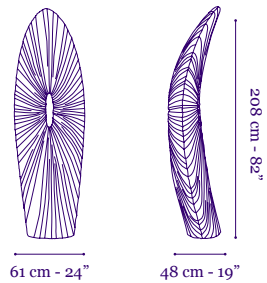

Viola
Floor and Table Lamp



Viola Floor and Table lamps in Rosewood and Grass silk

220-240V
CFL Screw-in 4 x 15W bulbs
Optional:
CFL Screw-in dimmable
[Type A] 4 x 20W bulbs
With dimmer

120V UL listed
CFL Screw-in dimmable
[Type A] 4 x 14W bulbs
With dimmer

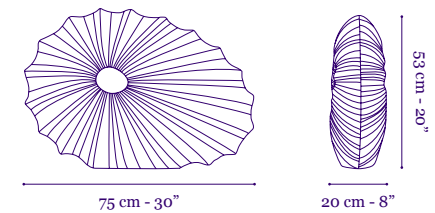

Contrare
Wall Fixture



Line of Contrare Wall fixtures in Red silk

220-240V
CFL Screw-in 2 x 23W bulbs
Optional:
CFL Screw-in dimmable
[Type A] 2 x 20W bulbs

120V UL listed
CFL Screw-in dimmable
[Type A] 2 x 23W bulbs

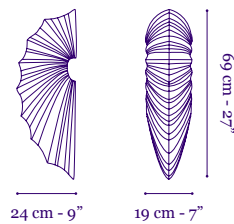

Same Same
Shelf Lamp



Same Same in Gold silk, Private Residence

220-240V
CFL Screw-in 3 x 15W bulbs
Optional:
CFL Screw-in dimmable
[Type A] 3 x 20W bulbs

120V UL listed
CFL Screw-in dimmable
[Type A] 3 x 14W bulbs

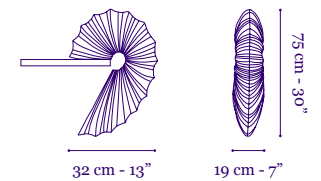

Liana

Wall and Ceiling Fixture



Liana Wall fixture in Custom pink silk

220-240 V Model

CFL Screw-in 10 x 15W bulbs

Optional:

Tubular FL with ECG

Dimmable [Type C, E, J]

4 x 55W bulbs

120 V Model

CFL Screw-in 10 x 14W bulbs

UL Listed

Optional:

Tubular FL with ECG

Dimmable [Type A]

4 x 55W bulbs

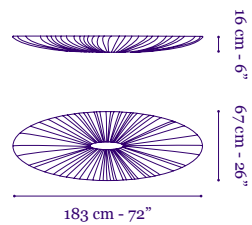

Liana in Smoke silk, Private Residence

Liana S.
Pendant



Liana S. in Silver silk
Liana S. pendants are suspended from an elliptical, black metal ceiling plate 15 cm - 6" on 72 cm - 28", by 2 metal cables, with a clear electrical cord, 200 cm - 79" long, adjustable height.

220-240V
Tubular FL with ECG
dimmable [Type C, E, J]
4 x 55W bulbs

120V UL listed
Tubular FL with ECG
dimmable
[Type A] 4 x 55W bulbs

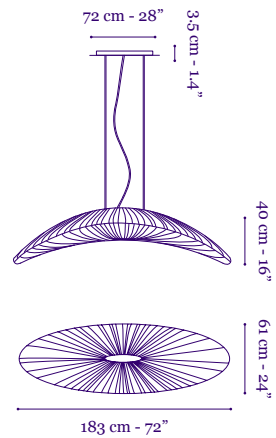

Liana S Pendant, Suuria Pendant, Morning Glory in Custom Green. Emerald Building, Chicago. Ph. Christopher Barrett



Morning Glory

Design by Aqua Creations

The Morning Glory Collection takes its inspiration from stylized organic forms. The designs are whimsical yet always elegant and include some of Aqua's most iconic pieces.

Morning Glory / Horn / Merkid /
64 Happy Days / 46 Happy Days /
Medusa / Evening Glory 100 /
Candy/ Fan / Coral / Baby Coral /
Dippa / Perlina / Suuria /
Suuria Son / Chili / Rotini /



Morning Glory Floor Lamp



Morning Glories in Coal and Silver silk

220-240V
Tubular FL with ECG
dimmable [Type C, E]
2 x 55W bulbs

120V UL listed
Tubular FL with ECG
dimmable [Type C, E]
2 x 55W bulbs

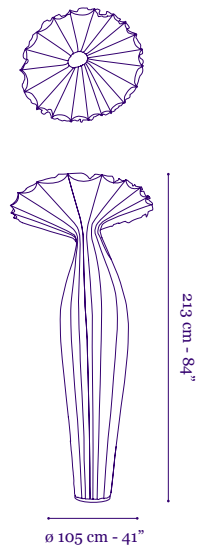

Limited Edition of 'Live and Let Dye' Custom printed Morning Glory

Horn
Floor Lamp



Horn Floor lamps in Dark silk

220-240V
Tubular FL with ECG
dimmable [Type C, E]
1 x 55W bulbs

120V UL listed
Tubular FL with ECG
dimmable [Type C, E]
1 x 55W bulbs

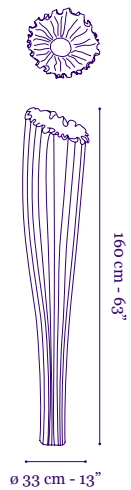

Merkid
Table Lamp



Merkid Table lamp in Curry, Rust, Redwood and Cream silk

220-240V
CFL Screw-in 1 x 23W bulb
Optional:
CFL Screw-in dimmable
[Type A] 1 x 20W bulb

120V UL listed
CFL Screw-in dimmable
[Type A] 1 x 23W bulb

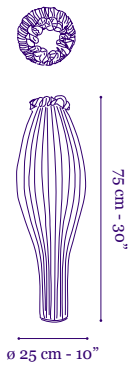

64 Happy Days

Floor Lamp



Happy Days 64 and 46 in Coal and Silver silk
The Happy Days are a perfect complement when paired together using the 46cm and the 64cm.

220-240V
CFL Screw-in 4 x 23W bulbs
Optional:
CFL Screw-in dimmable
[Type A] 4 x 20W bulbs
With dimmer

120V UL listed
CFL Screw-in dimmable
[Type A] 4 x 23W bulbs
With dimmer

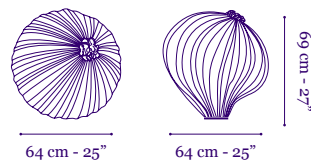

46 Happy Days

Floor Lamp



Happy Days 64 in Gold and Curry and Happy Days 46 in Grass

220-240V
CFL Screw-in 1 x 23W bulb
Optional:
CFL Screw-in dimmable
[Type A] 1 x 20W bulb
With dimmer

120V UL listed
CFL Screw-in dimmable
[Type A] 1 x 23W bulb
With dimmer

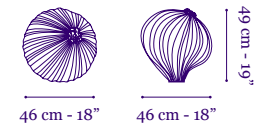

Medusa

Wall Fixture



Medusa Wall fixture in Orange silk

220-240V

CFL Screw-in 1 x 15W bulb

Optional:

CFL Screw-in dimmable

[Type A] 1 x 20W bulb

120V UL listed

CFL Screw-in dimmable

[Type A] 1 x 14W bulb

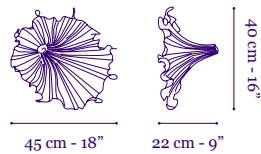

Evening Glory 100

Wall Fixture



Evening Glory 100 in Gold silk

220-240V

Tubular FL with ECG
dimmable [Type C, E, J]
2 x 55W bulbs

120V UL listed

Tubular FL with ECG
dimmable [Type A]
2 x 55W bulbs

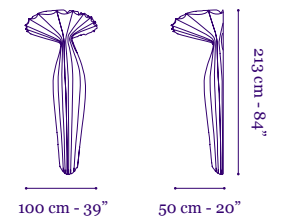

Custom light column in Orange silk. 300cm/10' high. Two of a group of seven



Custom Morning Glory 280 in Silver silk with Morning Glory in Dark silk

Candy
Wall Fixture



Candy in Flame silk
The Candy has left and right facing options. Please specify the required direction when ordering. It is recommended that the Candy be installed as a pair or a combination of pairs.

230V
CFL Screw-in 1 x 15W bulb
Optional:
CFL Screw-in dimmable
[Type A] 1 x 20W bulb

120V UL listed
CFL Screw-in dimmable
[Type A] 1 x 14W bulb

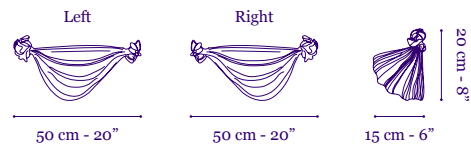

Fan
Wall Fixture



Fan in Orange and Rust silk
The Fan has left and right facing options. Please specify the required direction when ordering. It is recommended that the Fan be installed as a pair or a combination of pairs.

220-240V
CFL Screw-in 1 x 15W bulb
Optional:
CFL Screw-in dimmable
[Type A] 1 x 20W bulb

120V UL listed
CFL Screw-in dimmable
[Type A] 1 x 14W bulb

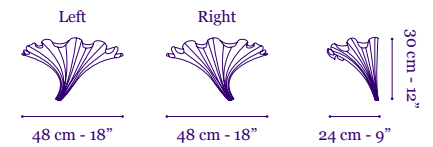



Coral and Baby Coral Ceiling fixtures in Cream silk, Private Residence

Coral

Wall and Ceiling Fixture



Coral wall fixture in Cream silk

220-240V

Tubular FL with ECG

2 x 55W bulbs

Optional:

Tubular FL with ECG

dimmable [Type C, E, J]

2 x 55W bulbs

120V UL listed

Tubular FL with ECG

2 x 55W bulbs

Optional:

Dimmable [Type A]

2 x 55W bulbs

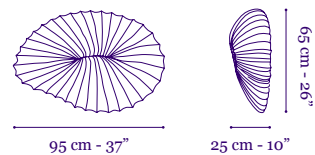

Baby Coral

Wall and Ceiling Fixture



Duo of Baby Corals in Stone silk

220-240V

CFL Screw-in 2 x 23W bulbs

Optional:

CFL with ECG dimmable

[Type C, E, J] 2 x 18W bulbs

120V UL listed

CFL Screw-in dimmable

[Type A] 2 x 23W bulbs

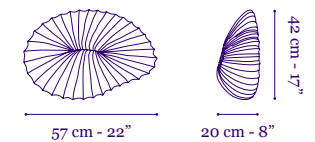

Dippa

Table Lamp or Pendant



Dippa table in Coal silk

Dippa pendants are suspended from a black ceiling plate 16 cm - 6.5" by a black electrical cord 200 cm - 78".

220-240V

CFL Screw-in 1 x 23W bulb

Optional:

CFL Screw-in dimmable

[Type A] 1 x 20W bulb

120V UL listed

CFL Screw-in dimmable

[Type A] 1 x 23W bulb

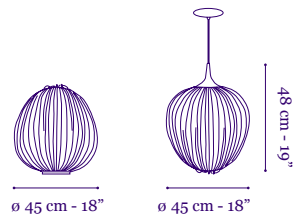

Custom Dippa, Dippa and Suuria pendant light installation in Rust, Redwood and Silver silk



Dippa Table lamp in and Suuria Pendant Redwood sill, Cosmopolitan Suite, St. Regis Istanbul

Perlina

Table Lamp or Pendant



Perlina Table in Redwood, Shell and Sand silk

Perlina pendants are suspended from a black ceiling plate 16 cm - 6.5" by a black electrical cord 200 cm - 78".

220-240V

CFL Screw-in 1 x 15W bulb

Optional:

CFL Screw-in dimmable

[Type A] 1 x 20W bulb

120V UL listed

CFL Screw-in dimmable

[Type A] 1 x 14W bulb

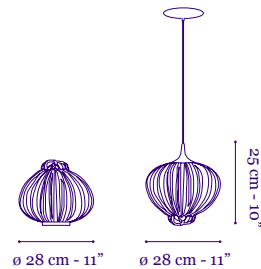

Suuria

Table Lamp or Pendant



Suuria pendant in Custom Sky silk

Suuria pendants are suspended from a black ceiling plate 16 cm - 6.5" by a black electrical cord 200 cm - 78".

220-240V

CFL Screw-in 1 x 23W bulb

Optional:

CFL Screw-in dimmable

[Type A] 1 x 20W bulb

120V UL listed

CFL Screw-in dimmable

[Type A] 1 x 23W bulb

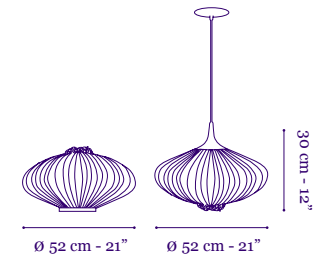

Suuria Son

Table Lamp or Pendant



Suuria Son Table in Coal silk

Suuria Son pendants are suspended from a black ceiling plate 16 cm - 6.5" by a black electrical cord 200 cm - 78".

220-240V

CFL Screw-in 1 x 23W bulb

Optional:

CFL Screw-in dimmable

[Type A] 1 x 20W bulb

120V

CFL Screw-in dimmable

[Type A] 1 x 23W bulb

UL Listed

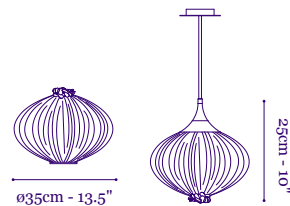

Chili

Pendant



Chili pendants in Flame silk
Chili pendants are suspended from a black ceiling plate 16 cm - 6.5" by a black electrical cord 200 cm - 78".

220-240V

CFL Screw-in 1 x 23W bulb

Optional:

CFL Screw-in dimmable

[Type A] 1 x 20W bulb

120V UL listed

CFL Screw-in dimmable

[Type A] 1 x 23W bulb

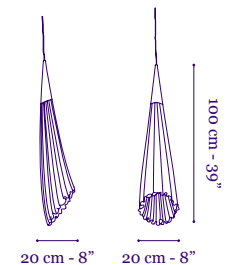



Dippa, Suuria and Suuria Son in Coal silk

Rotini
Pendant



Bottom view of Rotini 208 x 140 in Stone silk

220-240V

Rotini 140cm
Tubular FL T5 with ECG
dimmable [Type C, E, J]
4 x 55W bulbs

120V UL Listed

Rotini 55"
Tubular FL T5 with ECG
4 x 55W bulbs
Dimmable [Type A, E]

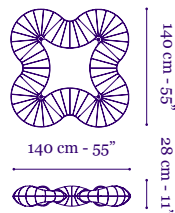

Rotini 208 x 140
Tubular FL T5 with ECG
dimmable [Type C, E, J]
6 x 55W bulbs

Rotini 82 x 55
Tubular FL T5 with ECG
6 x 55W bulbs
Dimmable [Type A, E]

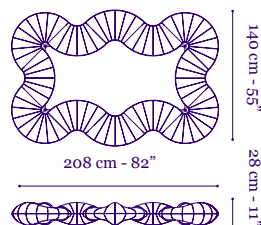

Rotini 140 in Shell silk at Sphinx Studio, Lucerne Switzerland



Palm

Design by Aqua Creations

The Palm Collection takes its inspiration directly from nature, while playing with movement and grace. The highly stylized curvilinear branches are made from hand-bent metal tubes wrapped in dark bronze or platinum organza fabric. The pieces in this collection are highly customizable to fit a specific space.

Palm Tree / Palm / 3 Palms /
5 Palms / 9 Palms /



Palm Tree in Cream silk and Bronze organza fabric

Palm Tree
Floor Lamp



220-240V
CFL Screw-in 3 x 15W bulbs
Optional:
CFL Screw-in dimmable
[Type A] 3 x 20W bulbs
With dimmer

120V UL listed
CFL Screw-in dimmable
[Type A] 3 x 14W bulbs
With dimmer

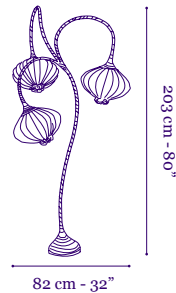

Palm
Wall Fixture



The Palm Wall has left and right facing options. Please specify the required direction when ordering. It is recommended that the Palm Wall be installed as a pair or a combination of pairs.

220-240V
CFL Screw-in 1 x 15W bulb
Optional:
CFL Screw-in dimmable
[Type A] 1 x 20W bulb

120V UL listed
CFL Screw-in dimmable
[Type A] 1 x 14W bulb

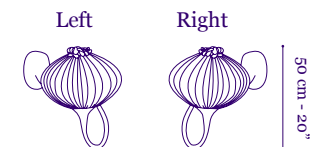

3 Palms
Ceiling Fixture



220-240V
CFL Screw-in 3 x 15W bulbs
Optional:
CFL Screw-in dimmable
[Type A] 3 x 20W bulbs

120V UL listed
CFL Screw-in dimmable
[Type A] 3 x 14W bulbs



146

5 Palms
Ceiling Fixture



220-240V
CFL Screw-in 5 x 15W bulbs
Optional:
CFL Screw-in dimmable
[Type A] 5 x 20W bulbs

120V UL listed
CFL Screw-in dimmable
[Type A] 5 x 14W bulbs

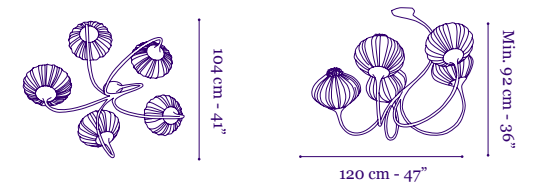

147

9 Palms
Ceiling Fixture



220-240V
CFL Screw-in 9 x 15W bulbs

120V UL listed
CFL Screw-in dimmable
[Type A] 9 x 14W bulbs

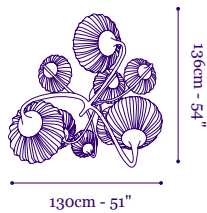

9 Palms in Cream silk and bronze organza fabric



Custom 14 Palms in Orange silk and Bronze organza fabric

Molecules

Design by Albi Serfaty in collaboration with
Origami artist Ilan Garibi

The Molecules Collection's origami shade begins with a blank sheet of paper that is folded and sculpted by hand into tessellations of individual molecules, with no cuts. The paper perfectly diffuses the light and easily sustains the folding and is complemented and contrasted by the mahogany wood structure. The lamps are powered by digitally dimmable LEDs, operated and controlled by touch. In Aqua's tradition, natural materials and artisanal manufacturing interact with technology; the result is elegant and luxurious lighting.

96 Molecules Table Lamp /
96 Molecules Tall Table Lamp /
96 Molecules Floor Lamp /
Five Molecules Mobile /
96 Molecules Wall Lamp /



96 Molecules

Table Lamp & Tall Table Lamp



96 Molecules Table lamp

100-240V UL listed pending
20W LED light source
4000k neutral white light color
Touch sensor dimming
(0-100%)

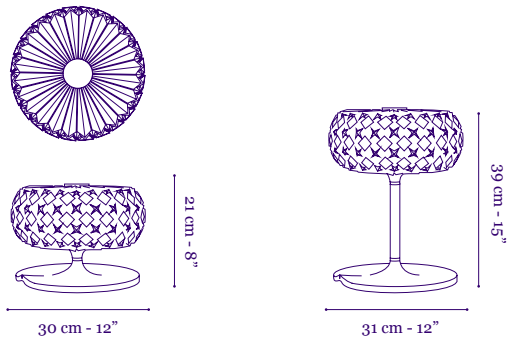

96 Molecules Tall Lamp

Floor Lamp



100-240V UL listed pending
20W LED light source,
4000k neutral white.
Touch sensor dimming
(0-100%)

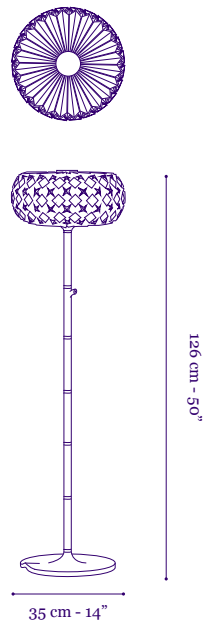

Five Molecules Mobile

Pendant Lamp



110-240V UL listed
5 x 20W LED bulbs
4000K neutral white.
Dimmable [Type C]

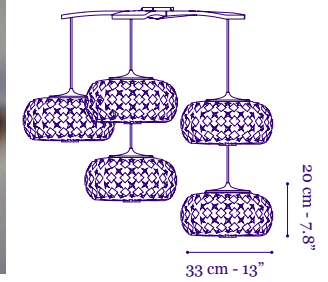
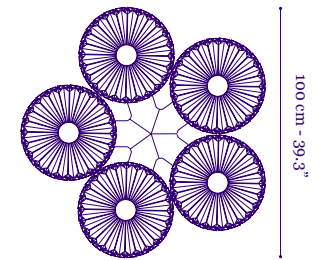

96 Molecules Wall
Wall Lamp



100-240V UL listed pending
20W LED light source
4000k neutral white light color
Push button dimming (0-100%)

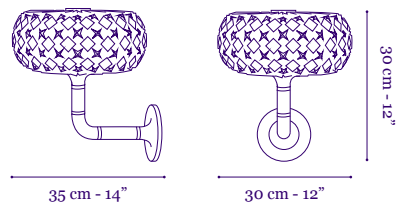

Mimosa

Design by Aqua Creations

The Mimosa collection was inspired by neurons and while the shape is organic it is contemporary and expresses subtleness and lightness. The shades are made from a laser cut, galvanized metal structure sprayed with clear polymer, resulting in a white membrane that perfectly distributes the light. The shades are sculpted by hand allowing some variations to occur from shade to shade. Mimosa is a highly customizable collection and may be adapted to fit spaces of any size.

Mimosa Pendant /
Mimosa Five Pendant /
Mimosa One Meter
Mimosa Flat Pendant /
Mimosa Floor Lamp /



Mimosa

Pendant & 5 Pendant



Suspended from a white powder coated ceiling plate Ø16cm - 6.5" by a clear electrical cable in adjustable height, up to 200cm - 78" long.

220 - 240V Model
CFL screw-in 1 x 35W bulb

120V UL listed
CFL screw-in 1 x 32W bulb

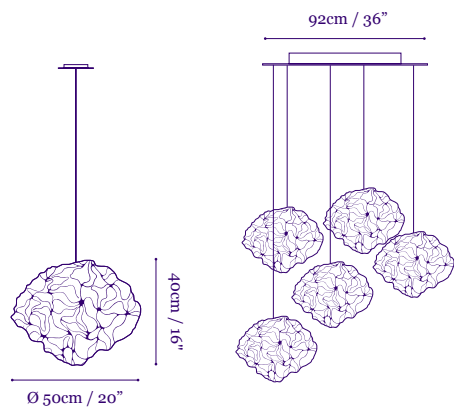

Mimosa One Meter
Pendant



220 - 240V Model
CFL screw-in 6 x 20W bulbs
Dimmable [Type A]

120V
CFL screw-in 6 x 23W bulbs
Dimmable [Type A]

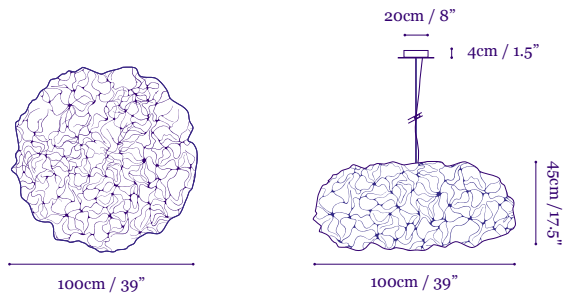

164

Mimosa Flat
Pendant



A set of three Flat Mimosa Pendants
This collection's visual appeal lies in the airy and cloudy effect it adds to any given space..

*Please advise length of metal stem; 65cm or 130cm. The shade is pivotable to a 30° angle.

220 - 240V Model
5 x 18W Ring LED modules
Dimmable [Type A]

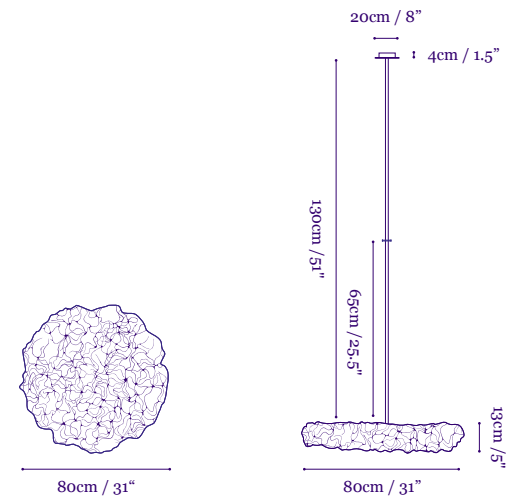

165

Mimosa Floor

Floor Lamp

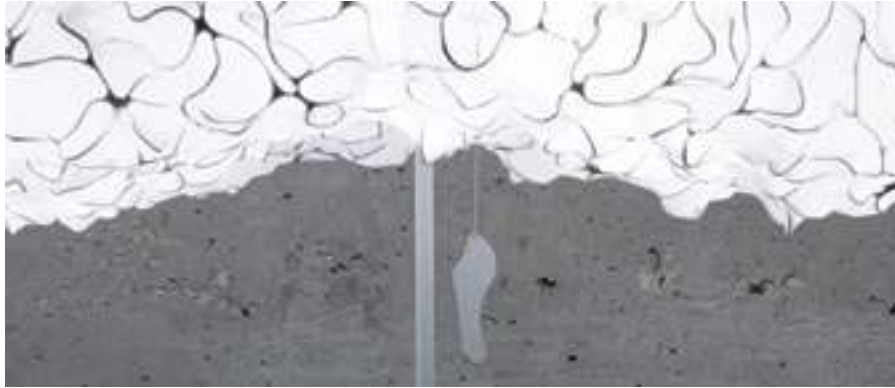

Detail of stainless steel pull switch in Mimosa Floor Lamp

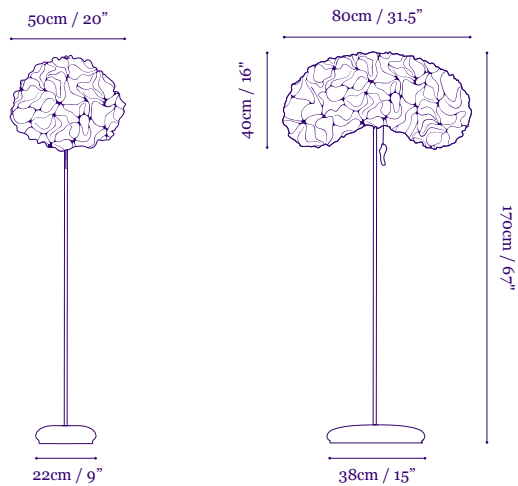

220 - 240V Model
CFL screw-in 2 x 23W bulbs

120V
CFL screw-in 2 x 23W bulbs
Dimmable [Type A]

*The base of the floor lamps
is made out of concrete.

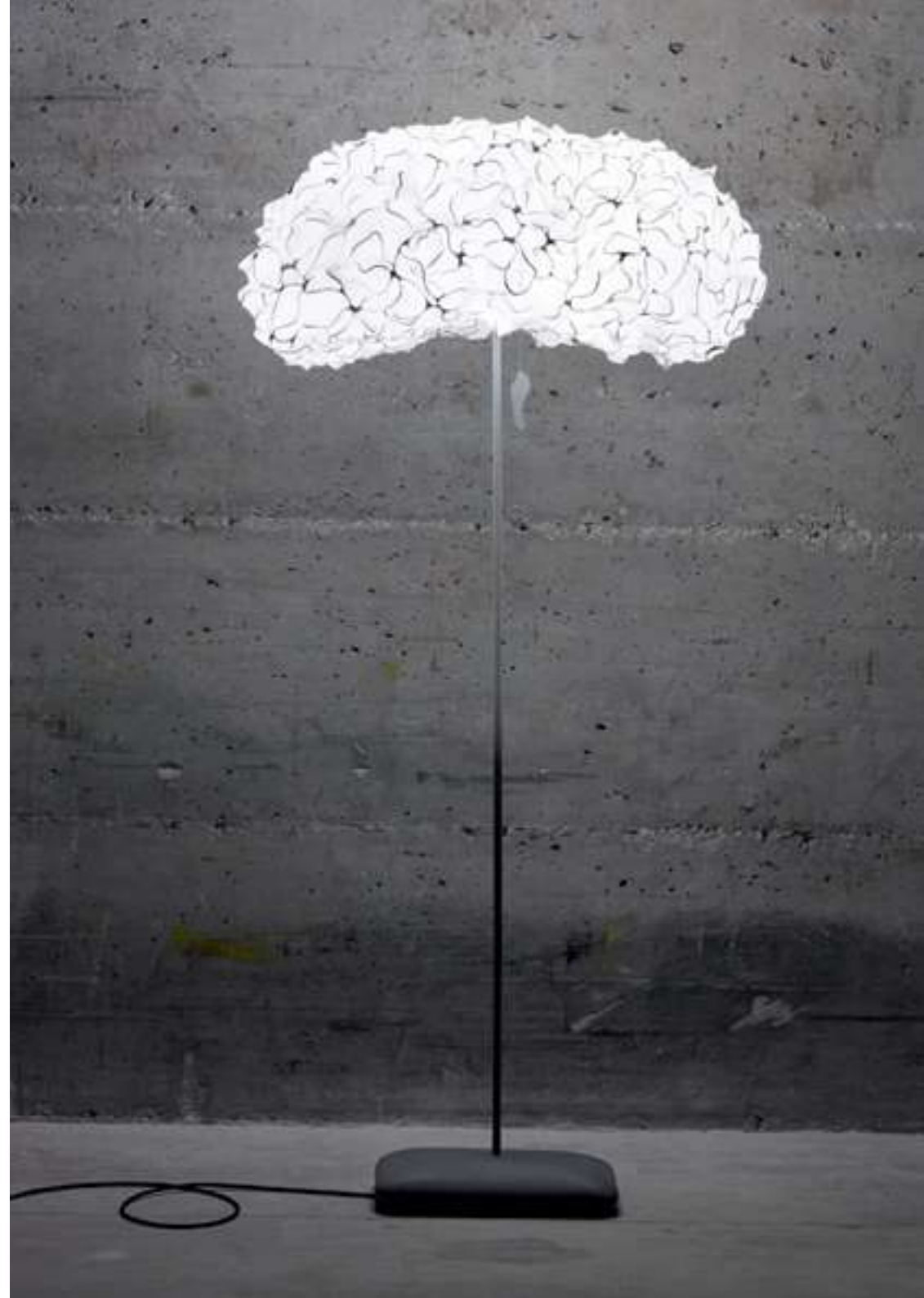

Apaya

Design by Aqua Creations in collaboration with Irit Dolman

The Apaya Collection celebrates the inherent qualities of natural color and structure; wool becomes a sculptural carrier of light in a uniquely aesthetic way. The pieces are all hand made using ecological and environmentally friendly materials. As it combines ancient wool felting techniques with modern lighting technology, the Apaya Collection safeguards heritage whilst re-inventing its future.

Limited Edition Apaya /
Apaya Tinka / Apaya Ponyo /
Apaya Pamuy /



Apaya Tinka
Floor Lamp

White merino and mohair
wools with long edges.



120 - 240V UL listed
Tubular FL with ECG
dimmable [Type C]
4 x 28W bulbs

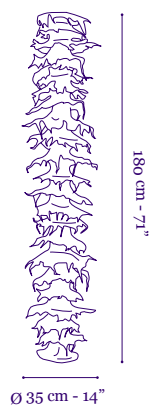

Apaya Ponyo
Floor Lamp



White merino and mohair wools.

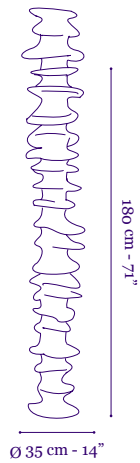

120 - 240V UL listed
Tubular FL with ECG
dimmable [Type C]
4 x 28W bulbs

Apaya Pamuy
Pendant



White merino and mohair wools with pure silk fibers. Apaya pendants are suspended from a brushed stainless steel ceiling plate and a clear electric cord.

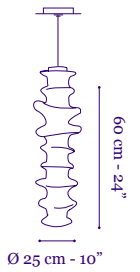

220-240V or 120V UL listed
Tubular FL with ECG
1 x 14W bulbs

Apaya Ponyo Floor Lamp at The James Hotel, New York



Live & Let Dye

Live & Let Dye, a Limited Edition of Aqua Creations' designs, reveals the brand's latest innovation; unique silk printing. Offering the possibility of a contemporary take on the brand's most classical signature pieces such as the Morning Glory. Lamps are either embellished with graduations of colour or unique photography, by Albi Serfaty, which are digitally printed before pleating on our signature Tussar silk, creating a new form of expression. No lamp is the same, making each piece completely unique and part of the "Live & Let Dye" limited edition.

Custom printed Morning Glory/
Custom printed Simon Says
Composition, "Dark Snow" /



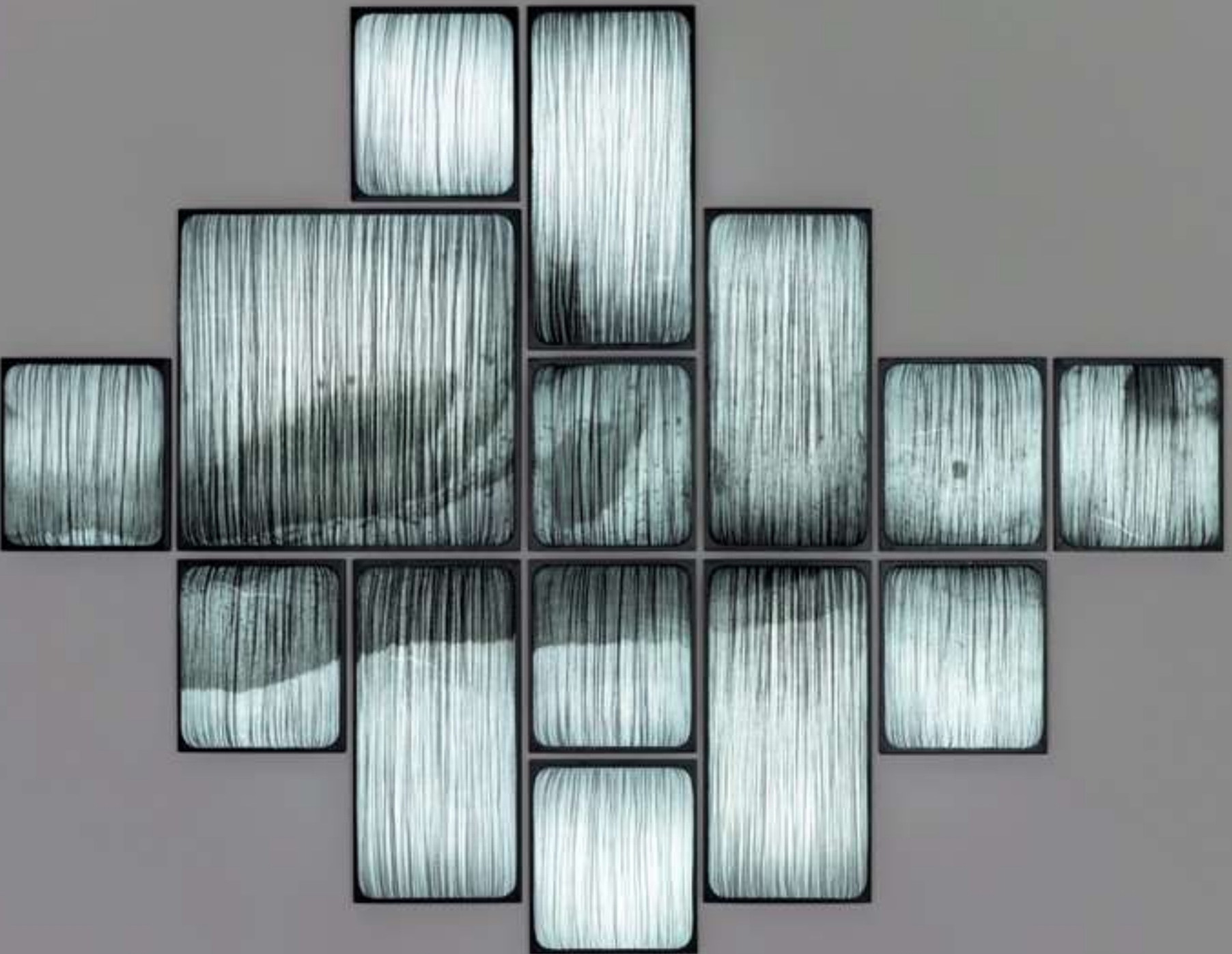

Furniture

Design by Aqua Creations

Aqua Creations' handmade furniture collections are contemporary and elegant. With custom options available, they are ideal for private living spaces as well as public environments.

Anana Poof / Anana Bench /
Gladis Love Seat /
Gladis Lounge Chair /
Shasta / Bubbles / Satala /



Anana Poof



Custom Anana Poof with a combination of different textured fabrics

Anana Collection

The Anana poof and Bench are shaped out off fabric covered pods tailored to form a 3 dimension surface. The collection is offered in a range of fabric colors, or customer's own material may be used. Fabric sample testing is required for that.

*Custom sizing and shapes available.

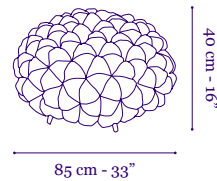

Anana Bench



Anana Bench with a combination of Ultrasuede fabric colours. Please inquire for available colour options.



Custom Anana Benches,
Kerquelen Shoe Store,
New York, USA

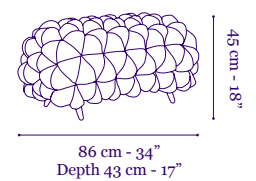

Gladis
Love Seat



Gladis Love Seat in Conan 29- Berry colour fabric
Please inquire for available fabric upholstery options.

Gladis
Lounge Chair



Gladis Lounge Chairs in Conan 17- Mineral colour fabric

Gladis Collection

Originating with the idea of one's own topography, the special hand stitched upholstery is reminiscent of the fluid forms of nature. The collection is offered in a range of fabric colors, or customer's own material may be used.

*Custom sizing and shapes available.

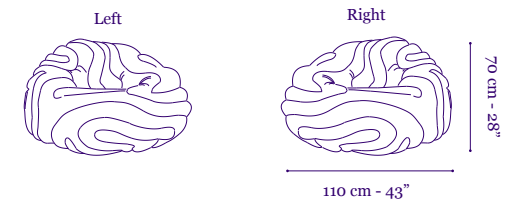
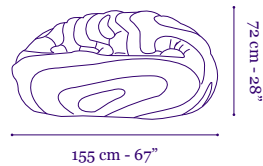



Custom Apaya Floor and Table Lamps, custom Gladis Lounge Chairs, Shasta Stools and a custom Satala Hammock in a private residence

Shasta
Table



Shasta Ceramic tables in White and Black finish.

Shasta has a simple and minimalistic aesthetic. The organic shape, smooth contours and clean lines of this sculptural element were created in collaboration with ceramic artist Marcelle Klein

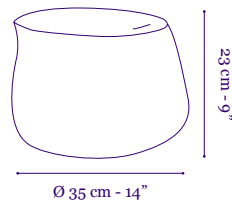

Bubbles
Stool



Bubbles is a unique stool upholstered with a hand stitched, 3 dimensional silver lycra garment. It is a unique furniture piece available in one fabric / color option.

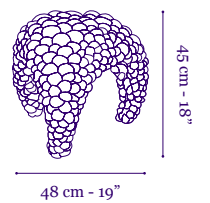

Satala Hammock



Satala Hammock
Please inquire for available fabric upholstery options.

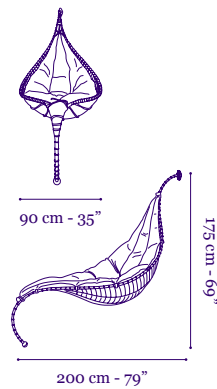

The unique design, supported on one leg, allows the user to rock themselves once reclined. Suitable for indoor or outdoor use where sheltered, the Satala is made of galvanised metal painted in a bronze shade with a range of fabric colors or customer's own material used for the removable down-filled cushion.



Satala Hammock with Custom fabric

Custom Gladis Lounge Chairs, Private residence



This is Aqua.

Aqua Creations is a combination of artistic values, aesthetics and quality. Our atelier creates design objects that function as art pieces. The lights are hand made using advanced and sustainable lighting technology. Our upholstery is hand worked and finished like haute couture. The Collections are exclusive and purchased only from Aqua Creations and its worldwide partners.

We started the atelier in 1994 working from home. Today, one can see our creations all over the world and at Aqua Gallery, our flagship store on 78 Grand street in SoHo, New York.

We remain loyal to the same values as when we started. All our pieces are handmade to order by skilled artisans who craft each piece individually, with utmost care and respect for our heritage.

Aqua Creations is committed to design and to the production of site specific installations of any scale. We answer the challenges presented by our clients and their designers, working in partnership to realise solutions that turn dreams into reality.

It is a joy to see Aqua being a part of many commercial and residential projects world wide and we commit ourselves to pursuing our goal to create the finest products.

Albi Serfaty,
Founder and Creative Director



Outside view of Aqua Gallery on 78 Grand Street, New York, NY 10013



Lighting Technology

Aqua Creations pioneered the implementation of electronic ballasts with Digital Addressable Lighting Interface (DALI) which has a dimming range from 1 to 100% allowing them to match the diverse requirements of both commercial and residential projects. Computer controlled Light Management System may be used instead of dimming devices and in this case all compatibility issues should be negotiated with Aqua Creations and reflected in the order.

Aqua Creations offers several types of DALI ballast control:

1. Touch dimming and standard dimming control
2. Battery free wireless remote control
3. Computerized control

Aqua Creations successfully employs the above technologies in all regions of the world providing solutions compatible with local lighting industry standards. Aqua Creations also implements well known dimming types such as 1-10V control and phase dimming; leading and trailing edge.

Some luminaires require screw-in, self-ballasted bulbs and some require plug-in bulbs with an electronic control gear (ECG). Aqua Creations uses fluorescent bulbs in its silk lighting designs. These bulbs create less heat than incandescent bulbs, are highly efficient and have a lifetime of 10,000 to 12,000 hours. For optimal light diffusion, please use recommended bulbs only.

*Please Note:

As all lamps and furnishing are handmade the measurements provided in centimeters and inches have a +/- 2% tolerance.



Dimming Options and Recommendations

Dim Type A is a phase dimming for dimmable bulb or dimmable ballast with 2 wires only.

Dim Type C is DALI dimming and requires 5 wires (line, neutral, ground and 2 control wires which are uni polar) allowing dim control from a computer or from a push button. Suitable for smart home control systems, this kind of dimming is sometimes called Architectural Dimming.

Dim Type E is similar to Dim Type C but with a wall mounted remote control. Aqua Creations provide the receiver and transmitter; no control wires required. Suitable for places with 3 wire electrical system.

Dim Type J requires 5 wires but dimming is provided by changing control voltage, 1-10v with a dimming potentiometer.



Dippa Pendant combination in Orange silk

Silk Lighting

The monumental scale of lighting sculptures combined with the exquisite use of silk fabric has become Aqua Creations' trademark over the years. The result is sophisticated tailored luminaires that reveal a new dimension in lighting.

All shades within the Silk Lighting Collections are made of hand dyed, treated and crushed silk that is resistant to mold and fire. The silk is sculpted over a metal structure.

As our fabrics are hand dye, hues may vary slightly.

When lit, the silk colors change with use of warm or cool white bulbs. In order to create a contemporary atmosphere we use warm white, 2700-3000 Kelvin (equivalent to OSRAM 830) bulbs for the colors: Cream, Red, Flame, Rust, Orange and Curry.

Neutral white, 4000 Kelvin (equivalent to OSRAM 840) bulbs, are recommended for the colors: Redwood, Sand, Shell, Gold, Coal, Dark, Stone, Silver, Smoke, Turquoise and Grass.

Coal



Stone



Silver



Dark



Smoke



Red



Flame



Rust



Orange



Grass



Turquoise



Gold



Cream



Shell



Curry



Sand



Redwood



Furniture Fabrics Options

Aqua Creations furniture collections Anana, Gladis and Satala may be upholstered with a range of fabric colors (see below) or the client's own materials where a sample is supplied to Aqua Creations for suitability testing NB quantities per furniture item will be advised when ordering.

Hemp



Flax



Mineral



Dragonfly



Fjord



Marine



Sepia



Military



Pistachio



Canyon



Spicy



Berry



Burgundy



Aubergine



Flint



Coconut



Castor



Chinchilla



Pewter



Griffin



Protection and Care Instructions

Protective Silk Coating: Special commercial grade resin coating is available upon request. It is highly recommended for pieces intended for public installations or areas of humidity or smoke. This coating does not change the appearance of the silk, but strengthens the texture.

Silk Lighting Care Instructions: For optimal maintenance vacuum the silk frequently (make sure the vacuum cleaner is at low suction and use a clean attachment) and avoid direct sunlight or smoke. To remove stains use upholstery foam cleaner (as these vary from country to country, testing the product on a hidden spot first is recommended). In case of heavier dirt use a moist sponge and make sure to move it along the crushed line of the silk. Please do not clean coated lamps with water.

Please Note: any good quality silk fibers weaken when exposed to sun and natural dyes may fade. Hence, avoid direct sunlight on the silk lights.

Apaya Lighting Care Instructions: The merino wool and silk sleeve should be dusted regularly and can easily be removed for dry cleaning.

Mimosa Lighting Care Instructions: The polymer covering the galvanized metal structure of the Mimosa shades is best cleaned by regular dry dusting with a feather duster or a dry cloth.

Molecules Lighting Care Instructions: The origami lamp shades in this collection are made of the best quality origami paper that easily resists environmental influences and changes. We recommend regular dry dusting with a feather duster or a very soft (paint) brush in order to maintain the appearance and quality.

Upholstery Fabric Care Instructions: Regular cleaning is important in order to keep the upholstery looking its best and to prolong its life. Dust and dirt wear down the textile. We recommend regular vacuum cleaning and removing non-greasy stains using a moist cloth or sponge. Do not rub the upholstery fabric too roughly.



Aqua Creations is represented by
Aqua Gallery, 78 Grand Street, SoHo
New York, NY 10013, USA

Tel. +1 212 219 9922, Fax +1 212 219 4042
info@aquagallery.com, www.aquagallery.com

